

# DELABIE



ACCESSIBILITY  
ACCESSORIES

# DELABIE

## CONTACTS

### HEAD OFFICE & PRODUCTION SITE

18, rue du Maréchal Foch  
80130 Friville  
FRANCE

delabie.com

### EXPORT

Tel. +33 (0)3 22 60 22 72  
export@delabie.fr

### QUOTES

Tel. +33 (0)3 22 60 22 72  
export.quotes@delabie.fr

### TECHNICAL SUPPORT

Tel. +33 (0)3 22 60 22 74  
Fax +33 (0)3 22 30 31 07  
sav@delabie.fr



Certification  
ISO 9001: 2015  
quality management  
systems

## ACS

**Certificate of Sanitary Conformity.**  
All DELABIE products conform to the CPDW\* directive modified 29/05/1997, and the French Ministry of Health circular DGS/SD7A2002 no. 571 dated 25/11/2002.

\* Construction Products in Contact with Drinking Water (European Commission).



# DELABIE's commitment!



### DELABIE PRODUCTS HAVE A 30-YEAR WARRANTY!

DELABIE products are designed to last for as long as possible. The quality of our products is such that we have no hesitation in **guaranteeing our products for 30 years\***.



### DELABIE PRODUCTS CAN BE REPAIRED FOR 50 YEARS!

We will keep **spare parts for our products for 50 years\*** to facilitate any necessary repairs.

DELABIE is helping to minimise your costs and prolong product lifespans, thereby reducing your ecological footprint.

\* see Terms and Conditions of Sales from 1<sup>st</sup> January 2024

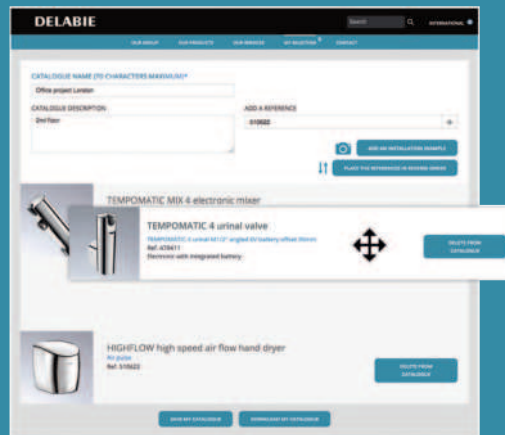

## DELABIE.COM AVAILABLE FEATURES

Create your own catalogue using your own product selection.

You can personalise it by giving it a project name and description, by choosing the order for the products to appear and by adding lifestyle images.

This catalogue will then be available in **Word, PDF and Excel** formats.

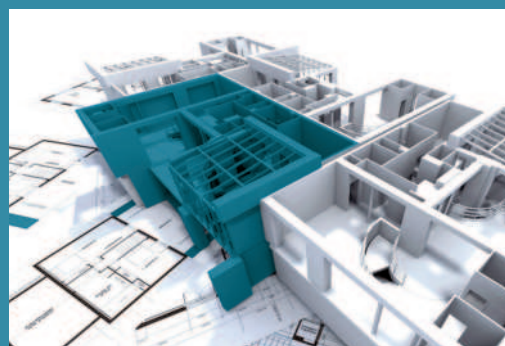

## BIM: DELABIE'S CORE PRODUCTS ARE NOW AVAILABLE

To meet the requirements of BIM technology, DELABIE has modelled its core products.

BIM files can be downloaded via the relevant product data sheet or via datashare.

The list of references available in BIM format is available in **Our Services - BIM Files**.



## TRENDS THE MAGAZINE: THE DESIGN TRENDS TAB

Browse the "Trends by DELABIE" magazine intended for those who are passionate about Design and the art of the "Beautiful".

Discover the 4 universes of "Trends" with major international projects, specification trends as well as interviews with prominent designers and architects who talk about their projects and their passions.

## DELABIE



MIRROR CABINET WITH 4 FUNCTIONS .....	9
HAND DRYERS, PAPER TOWEL & SOAP DISPENSERS.....	12
TOILET PAPER DISPENSERS, TOILET BRUSH SETS.....	34
MIRRORS, COAT HOOKS, TOWEL RAILS .....	43
GRAB BARS .....	50
SHOWER CURTAIN RAILS & SHOWER CURTAINS .....	52
ECONOMY PROJECTS RANGE .....	56

**HYGIENIC  
ACCESSORIES  
FOR PUBLIC  
AND COMMERCIAL  
PLACES**  
**3**



SHOWER SEATS.....	63
GRAB BARS & DROP-DOWN SUPPORT RAILS.....	69
SHOWER GRAB BARS.....	74
ACCESSORIES.....	78

**ACCESSIBILITY  
BE-LINE® RANGE**  
**59**

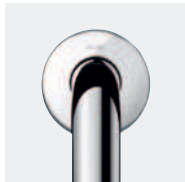

SHOWER SEATS.....	87
GRAB BARS & DROP-DOWN SUPPORT RAILS.....	91
SHOWER GRAB BARS.....	96
ACCESSORIES.....	104
STAINLESS STEEL SANITARY WARE FOR PEOPLE WITH REDUCED MOBILITY .....	110

**ACCESSIBILITY  
STAINLESS STEEL  
RANGE**  
**83**

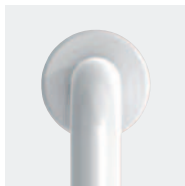

SHOWER SEATS.....	117
GRAB BARS .....	121
DROP-DOWN SUPPORT RAILS.....	123
SHOWER GRAB BARS.....	124
ACCESSORIES.....	132

**ACCESSIBILITY  
NYLON CLEAN  
RANGE**  
**113**



SHOWER SEATS & STOOL.....	141
WHITE BASIC GRAB BARS.....	144
SATIN FINISH BASIC GRAB BARS .....	147
ECO GRAB BARS.....	148

**ACCESSIBILITY  
BASIC & ECO  
RANGES**  
**139**

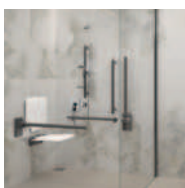

DOC M PACKS.....	152
DOC M PRODUCTS.....	157
DOC M SPACE GUIDES.....	160

**ACCESSIBILITY  
DOC M RANGE**  
**151**



ACCESSIBILITY - INDEPENDENCE INSTALLATION ADVICE.....	163
--	-----

**SPACE  
GUIDES**  
**163**

SPARE PARTS.....	172
REFERENCES INDEX.....	174

**INDEX**  
**171**



DELABIE

# Hygienic accessories for public and commercial places

WASHBASINS  
**9**



WCs  
**34**



BATHROOMS  
**43**



GRAB BARS  
**50**



SHOWERS  
**52**



ECONOMY RANGE  
**56**





### MAXIMUM HYGIENE

#### Stainless steel:

##### a material that limits bacterial proliferation

The majority of DELABIE's accessories are made from bacteriostatic 304 stainless steel. With this type of stainless steel, a thin, invisible protective layer forms continuously when in contact with air or water. Even if the surface is damaged mechanically, the **stainless steel is protected against corrosion**. The surface remains bright, hard and smooth, preventing bacteria from easily adhering to the surface. Bacterial development is therefore slower compared to other materials. Studies have regularly proven the aseptic qualities of stainless steel.

It is a noble metal alloy ideally suited to environments that demand high standards of hygiene (for example hospitals, retirement homes, schools, canteens, public washrooms, etc.).

#### Bright polished and polished satin finishes: cleaning is easy and sustainable

Using surfaces that are easy to clean and disinfect reduces the spread of bacteria. DELABIE's bright polished finish and polished satin finish provide the accessories with a uniform, non-porous surface. They are easy to clean and require less cleaning product. **Bacterial retention after cleaning is extremely low**, up to 20 times less than for other materials such as glass or plastic.

Studies show that after several cycles of daily soiling and cleaning, polished stainless steel retains less dirt and fewer residual bacteria than copper which also has bactericidal properties. Copper surfaces degrade over time, making them more difficult to clean. Polished stainless steel provides better hygiene by facilitating sustainable cleaning.

#### Hygiene-friendly design

DELABIE's accessories are designed to meet the obvious and essential principle of hygiene i.e. frequent cleaning. One-piece covers with **fewer niches where bacteria can develop** and soap tanks that prevent the soap from stagnating both contribute to effective cleaning and good hygiene.

### MAXIMUM ENDURANCE

#### High resistance to vandalism

DELABIE's hygienic accessories generally have thicker metal than most products available on the market. This **robust design** offers a high level of resistance to vandalism, appropriate for places subject to intensive use.

To prevent theft, very common in public facilities, a large number of DELABIE's hygienic accessories feature concealed fixings and/or locks with a key. The option to use the **standard DELABIE key** for the majority of DELABIE's products with locks, makes servicing them easy for maintenance staff.

#### Suitable for intensive use

All DELABIE's products undergo performance tests under extreme conditions. They are **specifically designed for intensive use** in all types of highly frequented public and commercial places.

### DESIGN

#### DELABIE's products have a timeless design.

The diversity of the product range fits perfectly with any commercial installation. In an office building or shopping centre it is paramount that the product design fits in with its surroundings.

DELABIE's hygienic accessories are generally available in three finishes: bright polished stainless steel, polished satin stainless steel and white powder-coated finishes.

Therefore, they can adapt to all types of materials and to **different interior decoration styles**.

#### Paint it BLACK!

DELABIE has extended its range of accessories in a matte black finish to expand the range that already exists.

It matches the BLACK BINOPTIC mixers and taps and Black Magic sanitary ware perfectly (see our *Commercial Water Controls* and *Stainless Steel Sanitary Ware catalogues*).

### AND ALSO...

#### Complete range

DELABIE's range provides solutions for a whole variety of different installations such as bathrooms, washrooms, en suites, etc. The quality image of stainless steel associated with the sleek design of DELABIE's hygienic accessories make them the perfect complement to DELABIE's other ranges.

#### 100% recyclable

Stainless steel is 100% recyclable, contributing to sustainable development and protecting the environment. DELABIE's stainless steel products contain 50-65% recycled stainless steel.









**ADJUSTABLE HINGES**  
Easy to install

**FIXINGS FOR HORIZONTAL  
and VERTICAL ADJUSTMENT**  
Easy to install

**CUT-OUT FOR TOP  
or WALL WATER SUPPLY  
CONNECTION**  
Easy to install

**A SINGLE ELECTRICAL  
CONNECTION FOR ALL  
THE ELEMENTS**  
Easy to install

**TAP:  
REDUCED STAGNATION  
SOLENOID VALVE, DUTY  
FLUSH**  
Maximum hygiene

**FLOW RATE 3 LPM  
ADJUSTABLE TO 1.4 L/MIN**  
Water saving

**AIR-PULSE HAND DRYER**  
High speed: dries in 10 - 12  
seconds



**MATTE BLACK FINISH**  
Design

**AMBIENT LIGHTING WITH  
LED STRIP FACING THE  
BASIN**  
Design

**LOCK WITH STANDARD  
DELABIE KEY**  
Vandal-resistant

**SPOUT WITH  
SCALE-RESISTANT  
FLOW STRAIGHTENER**  
Hygiene

**5L SOAP TANK**  
Easy to maintain

**NO-WASTE AND ANTI-BLOCKING  
SOAP PUMP DISPENSER**

**ILLUMINATED  
PICTOGRAMS  
FOR INTUITIVE USE**  
Design and ergonomic



## 4-in-1 or 3-in-1 mirror cabinet

Mirror, water, soap and hand drying

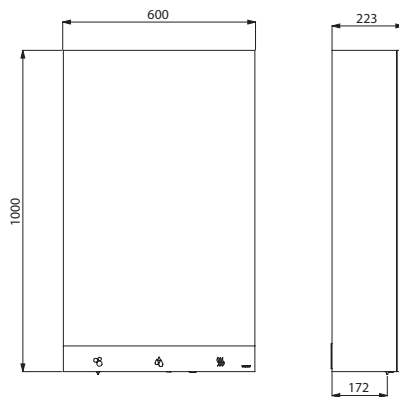

510203-510205

4-in-1 mirror cabinet	
<b>With hand dryers</b>	
Width 600mm	510203
Width 800mm	510204
<b>With paper towel dispensers</b>	
Width 600mm	510205
Width 800mm	510206
3-in-1 mirror cabinet	
<b>With hand dryers</b>	
Width 600mm	510207
Width 800mm	510208
<b>With paper towel dispensers</b>	
Width 600mm	510209
Width 800mm	510210

- **Mirror cabinet with 4 or 3 functions:** mirror, electronic soap dispenser, electronic tap (included in the 4-in-1 mirror cabinet) and hand dryer or paper towel dispenser.
- **Designer cabinet** with a matte black melamine and 304 stainless steel finish.
- **Touch-free** for improved hygiene: soap dispenser, tap and hand dryer are activated automatically when hands are detected by infrared sensor.
- **Quick and easy to install:**
  - A single electrical connection for all the elements: mains supply with 230V / 50-60Hz.
  - Connects to the water supply from the top or from inside the cabinet.
  - Water connection in M3/8".
  - Concealed fixings: supplied with stainless steel screws for concrete or reinforced wood.
  - Adjustable hinges.
- Glass mirror and black glass strip with **illuminated pictograms**.
- **Automatic soap or foam dispenser:**
  - No-waste pump dispenser.
  - Large capacity tank: 5 litres.
  - Suitable for vegetable-based **liquid soap** with a maximum viscosity of 3,000 mPa.s or **specific foam soap**.
- **Electronic basin tap** (included in the 4-in-1 mirror cabinet):
  - Reduced stagnation solenoid valve.
  - **Flow rate pre-set at 3 lpm** at 3 bar, can be adjusted from 1.4 to 6 lpm.
  - Scale-resistant flow straightener.
  - Duty flush (~60 seconds every 24 hours after the last use).
  - Stopcock.
  - For mixed water, we recommend a PREMIX mixer see the DELABIE catalogue "Water Controls for Public & Commercial Places" (DOC 609 INT).
- **Models with air-pulse hand dryer:**
  - **High speed drying:** dries in 10 - 12 seconds.
  - Pulsed air at 360km/h. Airflow: 36 l/second.
  - Low energy consumption: 704W.
  - Noise level: 74 dBA.
  - Class I, IP23. CE.
  - 3-year warranty.
- **Models with paper towel dispenser:**
  - Dispenses one sheet at a time.
  - Dimensions: 120 × 275 × 360mm.
  - Contents: 500 sheets.
- Basin lit by the LED strip.
- **Vandal-resistant model** with standard DELABIE key.
- **Anti-blocking:** stops automatically if used continuously.
- Internal storage shelf.
- **Several cabinets can be installed side-by-side** to create a mirror wall: linking screws are provided.
- 30-year warranty (hand dryer 3-year warranty).
- CE marked.

### 3-in-1 unit

Soap, water and hand drying



- Unit with 3 functions: electronic soap dispenser, tap and hand dryer or paper towel dispenser (see technical information of those three products page 8).
- Quick and easy to install in a cabinet or behind a mirror.
- Fixings on the sides and the back.
- 304 stainless steel support, 1.2 mm thick.
- Supplied with self-adhesive pictograms to indicate the location of the different functions on the mirror/cabinet: soap, water and air.
- Vandal-resistant model with standard DELABIE key.
- 30-year warranty (hand dryer 3-year warranty).
- CE marked.

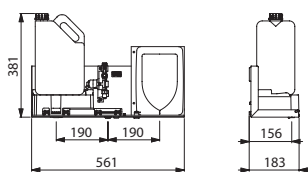

5102031

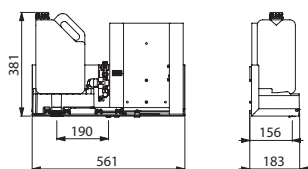

5102051

3-in-1 unit for installation behind a mirror	
With hand dryer	5102031
With paper towel dispenser	5102051

### 2-in-1 unit

Soap and hand drying



- Unit with 2 functions: electronic soap dispenser and hand dryer (see technical information of those products page 8).
- Quick and easy to install in a cabinet or behind a mirror.
- Fixings on the sides and the back.
- 304 stainless steel support, 1.2 mm thick.
- Supplied with self-adhesive pictograms to indicate the location of the different functions on the mirror/cabinet: soap and air.
- Vandal-resistant model with standard DELABIE key.
- 30-year warranty (hand dryer 3-year warranty).
- CE marked.

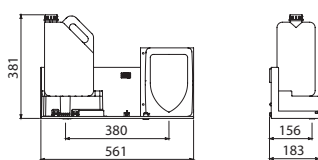

5102071

2-in-1 unit with hand dryer for installation behind a mirror	
	5102071

### Electronic soap dispenser unit



- Electronic soap dispenser : touch-free for improved hygiene.
- Quick and easy to install in a cabinet or behind a mirror.
- Fixings on the sides and the back.
- 304 stainless steel support, 1.2 mm thick.
- Mains supply with 100-240V / 6V 50 60 Hz. transformer.
- Supplied with self-adhesive pictogram to indicate the location of the soap dispenser on the mirror/cabinet.
- No-waste pump dispenser.
- Large capacity tank: 5 litres.
- Suitable for vegetable-based liquid soap with a maximum viscosity of 3,000 mPa.s or specific foam soap.
- 30-year warranty.
- CE marked.

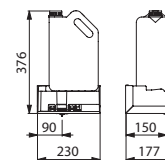

510203SD

Electronic soap dispenser unit for installation behind the mirror	
	510203SD



**TWO-WAY AIR PULSE  
HAND DRYER**  
High speed drying



**ANTI-BLOCKING SYSTEM**  
Vandal-resistant

**WARNING LIGHTS**  
Easy to maintain

**WARM AIR**  
Comfort

**SLEEK DESIGN**  
3 finishes available

**3-YEAR WARRANTY**

**HEATING ELEMENT STOPS  
AUTOMATICALLY  
IF THE TEMPERATURE  
IS > 25°C**  
Energy saving

**ANTI-BACTERIAL ABS**  
Maximum hygiene

**LOW ENERGY  
CONSUMPTION**

**REMOVABLE DRIP TRAY**  
easy to clean and maintain

**HEPA FILTER**  
Retains 99.99% of bacteria

**SPEEDJET air pulse hand dryer**



- Two-way air pulse hand dryer.
- **High speed:** dries in 10 to 18 seconds.
- **Removable drip tray** prevents any water dripping onto the wall or floor: easy to clean and service.
- ON/OFF button: easy to service.
- **Anti-bacterial air filter and activated carbon filter.**
- Infrared automatic activation.
- Intelligent technology: stops automatically when hands are removed or after 18 seconds.
- LCD screen with animated user guide and automatic stand-by.
- Brushless motor, no wear.
- **Energy saving: power 850W.** No heating element.
- 220-240V~ / **50-60Hz.**
- Airflow: 42 l/second. Air speed: 310km/h.
- Noise level: 75-80 dBA.
- Dimensions: 250 × 292 × 650mm.
- Weight: 11.4kg.
- Class I, IP22.
- CE marked.
- **3-year warranty.**



**High speed drying  
10 to 18 sec.**

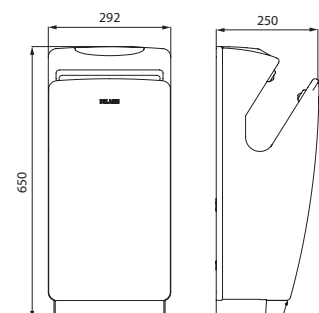
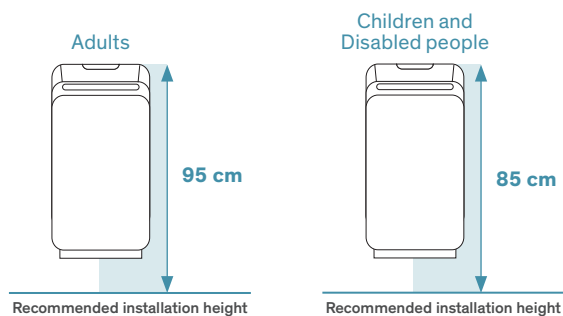

SPEEDJET air pulse hand dryer, metallic grey	510621
--	--------

510621

**SPEEDJET 2 air pulse hand dryer**

Anti-bacterial ABS



- Two-way air pulse hand dryer.
- **High speed:** dries in 10 to 12 seconds.
- **Removable drip tray** prevents any water dripping onto the wall or floor: easy to clean and service.
- Comfort: warm air.
- **Anti-bacterial ABS** for maximum hygiene.
- **HEPA filter:** captures 99.99% of airborne bacteria and purifies the expelled air.
- Infrared automatic activation.
- Intelligent technology: stops automatically when hands are removed.
- **Anti-blocking:** stops automatically if used continuously for more than 30 seconds.
- **Easy to maintain:** warning lights indicate when maintenance is required (change the HEPA filter, blockages, etc.).
- **Energy saving:** heating element stops automatically once room temperature reaches > 25°C.
- Low energy consumption: 1,050W in non-heating mode, 1,550W in heating mode.
- 220-240V~ / **50-60 Hz.**
- Airflow: 61 l/second. Air speed: 540km/h.
- Noise level: 66 dBA.
- Dimensions: 180 × 320 × 540mm.
- Weight: 6.83kg.
- Class II, IP21.
- CE marked.
- **3-year warranty.**



**High speed drying**  
10 to 12 sec.

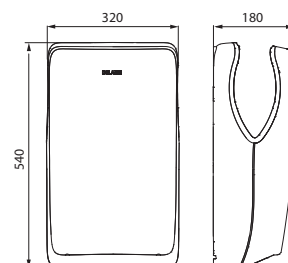

510624

SPEEDJET 2 air pulse hand dryer	
Metallised anthracite	<b>510624C</b>
Matte white	<b>510624W</b>
Matte black	<b>510624B</b>
HEPA filter	<b>510624F</b>



HIGHFLOW high-speed air pulse hand dryer **510622S** - Wall-mounted electronic liquid soap dispenser **512066S**  
Countertop ALGUI washbasin **120110** - BINOPTIC electronic tap **379ENC** - Unbreakable stainless steel mirror **3459**



**HIGHFLOW air pulse hand dryer**



- **Robust model.**
- **Lit central nozzle concentrates pulsed air onto hands at 230km/h.**
- **High speed:** dries in 10 to 12 seconds.
- Choice of **warm or cold air** via concealed switch.
- Infrared automatic activation.
- Intelligent technology: stops automatically when hands are removed.
- Anti-blocking: stops automatically if used continuously for more than 60 seconds.
- **Bacteriostatic 304 stainless steel.**
- Easy to clean: one-piece cover.
- Stainless steel thickness: 1mm.
- Airflow: 39 l/second. Air speed: 230km/h.
- Low energy consumption: 1,350W.
- 220-240V~ / **50 Hz.**
- Noise level: 70 dBA.
- Dimensions: 175 × 238 × 267mm.
- Weight: 4kg.
- Class I, IP23.
- CE marked.
- **3-year warranty.**



High speed drying  
10 to 12 sec.

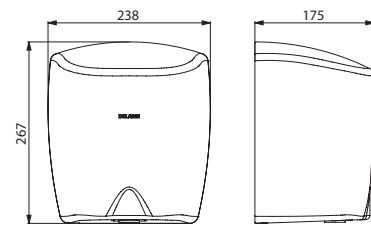

510622

**HIGHFLOW air pulse hand dryer**

Bright polished 304 stainless steel cover	<b>510622</b>
Polished satin 304 stainless steel cover	<b>510622S</b>
White powder-coated 304 stainless steel cover	<b>510622W</b>
Matte black powder-coated 304 stainless steel cover	<b>510622BK</b>

**HIGHFLOW Compact air pulse hand dryer**



- **Robust model.**
- **Lit central nozzle concentrates pulsed air onto hands at 360km/h.**
- **High speed:** dries in 10 to 12 seconds.
- Choice of **warm or cold air** via concealed switch.
- Infrared automatic activation.
- Intelligent technology: stops automatically when hands are removed.
- Anti-blocking: stops automatically if used continuously for more than 60 seconds.
- **Bacteriostatic 304 stainless steel.**
- Easy to clean: one-piece cover.
- Stainless steel thickness: 1mm.
- Airflow: 39 l/second. Air speed: 360km/h.
- Low energy consumption: 1,350W.
- 220-240V~ / **50 Hz.**
- Noise level: 70 dBA.
- Dimensions: 152 × 173 × 256mm.
- Weight: 3.1kg.
- Class I, IP23.
- CE marked. **3-year warranty.**



High speed drying  
10 to 12 sec.

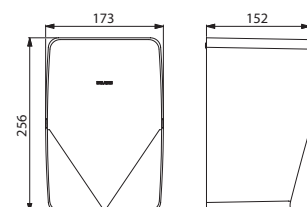

510625

*Provisional availability 1<sup>st</sup> half 2024. Please contact sales office to check availability.*

**HIGHFLOW Compact air pulse hand dryer**

Bright polished 304 stainless steel cover	<b>510625P</b>
Polished satin 304 stainless steel cover	<b>510625S</b>

**Automatic hand dryer**

With 360° rotating nozzle



- **Vandal-resistant model.**
- Automatically activated by optical cell.
- **360° rotating nozzle.**
- **Bright polished 304 stainless steel cover.**
- Stainless steel thickness: 1.2mm.
- **Power: 2,000W. 50-60Hz.**
- Airflow: 95 l/second.
- **Low noise level: 68 dBA.**
- Dimensions: 210 × 280 × 220mm.
- Weight: 3.5kg.
- Maximum safety, Class II insulation (double electrical insulation), IP23.
- CE marked, TÜV GS.
- **3-year warranty.**

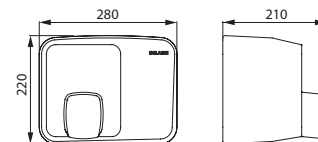

Automatic hand dryer with 360° rotating nozzle	6613D
--	-------

6613D

**Automatic hand dryer**



- Automatically activated by optical cell.
- **Power: 1,960W. 50Hz.**
- Airflow: 65 l/second.
- **Low noise level: 58 dBA.**
- Dimensions: 124 × 216 × 318mm.
- Weight: 3.8kg.
- Class II (ref. 6621), Class I (ref. 6631), IPX1.
- CE marked, TÜV GS.
- **3-year warranty.**

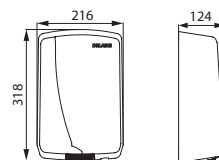

6631/6621

Automatic hand dryer	
Bright polished 304 stainless steel cover	6631
White ABS cover	6621

**Wall-mounted hair dryer**

With socket for shavers



- Operated by sensor switch.
- Safety switch on the cradle.
- 2 drying temperatures.
- **Shaver socket.**
- White ABS cover.
- **Power: 1,200W.**
- Airflow: 14 l/second.
- Dimensions: 90 × 180 × 170mm.
- Weight: 1.3kg.
- Class II. CE marked.
- **3-year warranty.**

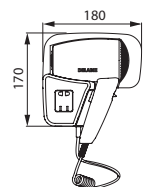

6624

Hair dryer	6624
------------	------

### Wall-mounted paper towel dispenser

For **500** paper towels



Bright polished 304 stainless steel

- With lock and **standard DELABIE key**.
- Level control.
- **Dispenses one sheet at a time.**
- **Capacity: 500 sheets.**
- Dimensions: 120 × 275 × 360mm.
- Paper towel dimensions: open 230 × 250mm, folded 115 × 250mm.
- 30-year warranty.



Polished satin 304 stainless steel



White powder-coated



Matte black powder-coated

Wall-mounted paper towel dispenser - 500 sheets	
Bright polished 304 stainless steel	<b>510601P</b>
Polished satin 304 stainless steel	<b>510601S</b>
White powder-coated	<b>510601W</b>
Matte black powder-coated	<b>510601BK</b>
Folded paper towels, pack of 180 sheets	<b>6606</b>

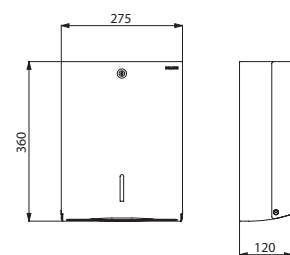

510601

**Wall-mounted paper towel dispenser - Large model**

For **750** paper towels



- With lock and **standard DELABIE key**.
- Level control.
- **Capacity: 750 sheets.**
- Metal thickness: 1mm.
- Dimensions: 120 × 275 × 450mm.
- Paper towel dimensions: open 230 × 250mm, folded 115 × 250mm.
- 30-year warranty.

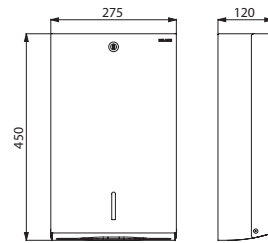

6601/6607D/6602

Wall-mounted paper towel dispenser - Large model - 750 sheets	
Bright polished 304 stainless steel	<b>6601</b>
Polished satin 304 stainless steel	<b>6607D</b>
White powder-coated	<b>6602</b>
Folded paper towels, pack of 180 sheets	<b>6606</b>

**Wall-mounted bin**

With flap, **16 litres**



- **Bacteriostatic 304 stainless steel.**
- **System for fixing a bag in the bin.**
- With lock and **standard DELABIE key**.
- Bright polished stainless steel flap.
- Capacity: 16 litres.
- Stainless steel thickness: 1mm.
- Dimensions: 130 × 275 × 475mm.
- 30-year warranty.

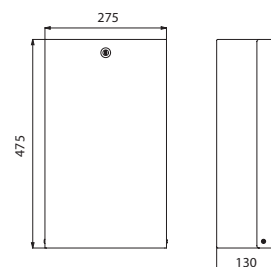

6611/6617/6612

16-litre wall-mounted bin	
Bright polished 304 stainless steel	<b>6611</b>
Polished satin 304 stainless steel	<b>6617</b>
White powder-coated 304 stainless steel	<b>6612</b>

### Wall-mounted rectangular bin

Without lid, 20 litres



- **Robust model.**
- Capacity: 20 litres.
- Metal thickness: 0.8mm.
- Dimensions: 170 × 275 × 480mm.
- 30-year warranty.

20-litre wall-mounted rectangular bin without lid	
Bright polished 304 stainless steel	<b>510465P</b>
Polished satin 304 stainless steel	<b>510465S</b>
White powder-coated	<b>510465W</b>
Matte black powder coated	<b>510465BK</b>

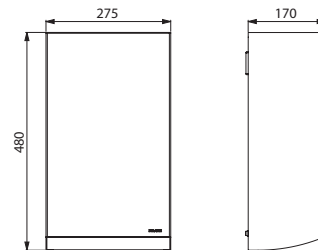

510465

### Wall-mounted rectangular stainless steel bin

Without lid, 25 or 38 litres



- **Robust model.**
- **Bacteriostatic 304 stainless steel.**
- Capacity: 25 or 38 litres.
- Stainless steel thickness: 1mm.
- 30-year warranty.

38-litre wall-mounted rectangular bin without lid	
Bright polished 304 stainless steel	<b>510463P</b>
Polished satin 304 stainless steel	<b>510463S</b>
25-litre wall-mounted rectangular bin without lid	
Bright polished 304 stainless steel	<b>510461P</b>
Polished satin 304 stainless steel	<b>510461S</b>

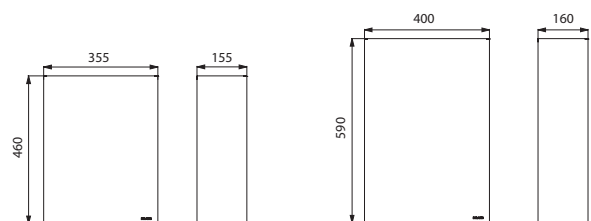

510461

510463

**Wall-mounted rectangular stainless steel bin**  
13 litres



- **Robust model.**
- Bright polished stainless steel.
- Capacity: 13 litres.
- Stainless steel thickness: 1mm.
- Dimensions: 150 × 280 × 320mm.
- 30-year warranty.

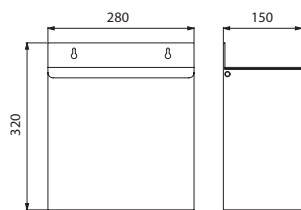

462

**13-litre bin - Bright polished stainless steel**

Without lid	<b>460</b>
With lid	<b>462</b>

**Slimline wall-mounted stainless steel bin**  
With lid, 4.5 litres



- **Robust model with lid.**
- Stainless steel.
- Capacity: 4.5 litres.
- Stainless steel thickness: 1mm.
- Dimensions: 70 × 210 × 310mm.
- 30-year warranty.

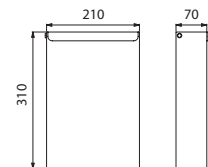

465

**4.5-litre slimline bin with lid**

Bright polished stainless steel	<b>465</b>
Polished satin stainless steel	<b>465S</b>

**Round pedal bin**  
5 and 3 litres



- Stainless steel.
- With plastic liner.
- Capacity: 5 or 3 litres.
- **For use with 5-litre bags.**
- 5L model dimensions: Ø 205mm, height 275mm.
- 3L model dimensions: Ø 170mm, height 265mm.
- 30-year warranty.

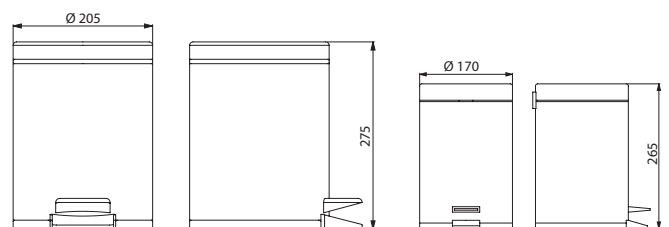

450P

449/1449

<b>5-litre pedal bin</b>	
Bright polished stainless steel	<b>450P</b>
<b>3-litre pedal bin</b>	
Bright polished stainless steel	<b>449</b>
White powder-coated stainless steel	<b>1449</b>



**Liquid soap dispenser**



- Polished satin bacteriostatic 304 stainless steel.
- Door with lock and standard DELABIE key.
- Plastic tank.
- Concealed fixings.
- Capacity: 1 litre.
- Stainless steel thickness: 1.2mm.
- Dimensions: 109 × 245 × 150mm.
- For chlorine-free and pH neutral soap.
- Compatible with hydroalcoholic gel.
- 30-year warranty.

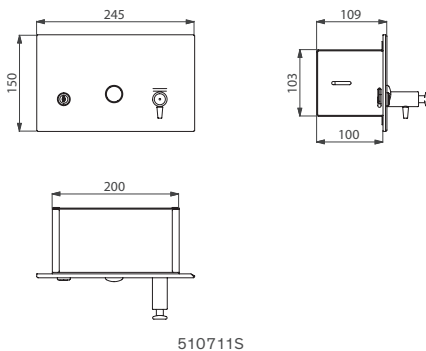

Soap dispenser	510711S
----------------	---------

**Paper towel dispenser**



- Polished satin bacteriostatic 304 stainless steel.
- Door with lock and standard DELABIE key.
- Concealed fixings.
- Capacity: 400 - 600 towels.
- Stainless steel thickness: 1.2mm.
- Dimensions: 122 × 330 × 435mm.
- 30-year warranty.

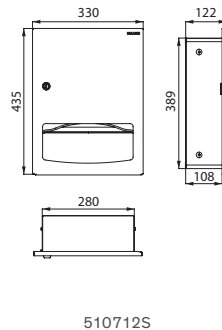

Paper towel dispenser	510712S
-----------------------	---------

**Waste bin**

With flap



- Polished satin bacteriostatic 304 stainless steel.
- PUSH flap.
- Door with lock and standard DELABIE key.
- Concealed fixings.
- Capacity: 18 litres.
- Stainless steel thickness: 1.2mm.
- Dimensions: 100 × 360 × 710mm.
- 30-year warranty.

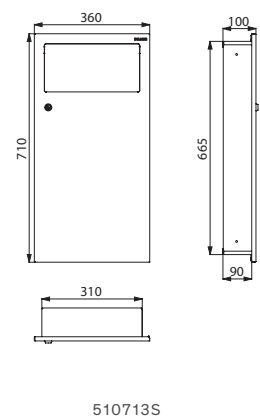

Waste bin with flap	510713S
---------------------	---------



**Combi paper towel dispenser/bin 10 litres**



- Polished satin bacteriostatic 304 stainless steel.
- Door with lock and standard DELABIE key.
- Concealed fixings.
- Dispenser capacity: 400 - 600 towels.
- Waste bin capacity: 10 litres.
- Stainless steel thickness: 1.2mm.
- Dimensions: 125 × 330 × 790mm.
- 30-year warranty.

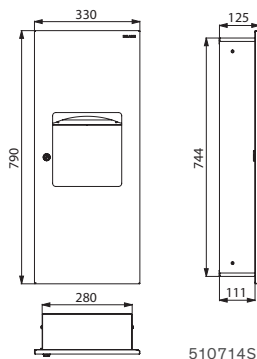

Combi dispenser/bin 10 litres      510714S

**Combi paper towel dispenser/bin 30 litres**



- Polished satin bacteriostatic 304 stainless steel.
- Door with lock and standard DELABIE key.
- Concealed fixings.
- Dispenser capacity: 400 - 600 towels.
- Waste bin capacity: 30 litres.
- Stainless steel thickness: 1.2mm.
- Dimensions: 160 × 395 × 1,395mm.
- 30-year warranty.

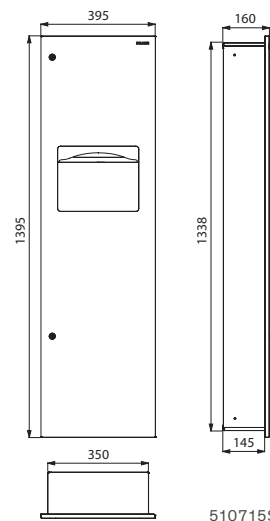

Combi dispenser/bin 30 litres      510715S

**Combi hand dryer and paper towel dispenser/bin**



- Polished satin bacteriostatic 304 stainless steel.
- Door with lock and standard DELABIE key.
- Concealed fixings.
- Dispenser capacity: 400 - 600 towels.
- Hand dryer power: 1,800W.
- IP23. 3-year warranty. CE marked.
- Waste bin capacity: 15 litres.
- Stainless steel thickness: 1.2mm.
- Dimensions: 160 × 395 × 1,420mm.
- 30-year warranty.

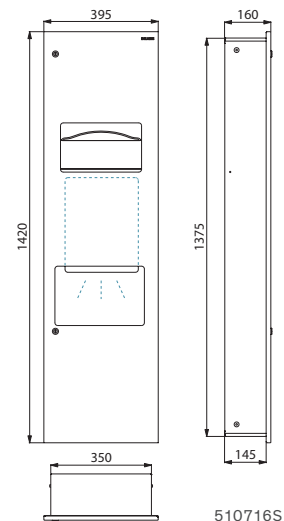

Combi dispenser/bin hand dryer      510716S



Electronic liquid or foam soap dispenser **512111P** - BINOPTIC electronic basin tap **379DER**  
Recessed combi paper towel dispenser / bin **510715S** - BAILA floor-standing washbasin **120172**

**BINOPTIC electronic liquid or foam soap dispenser**

Wall-mounted or cross wall, **mains supply**



- Wall-mounted or **vandal-resistant cross wall (TC)** up to 110mm.
- **No manual contact:** infrared cell detects hands automatically.
- Chrome-plated, satin finish or matte black 304 stainless steel spout.
- **No-waste dose dispenser.**
- Independent electronic housing and removable tank for installation beneath the washbasin.
- 100-240V / 50-60 Hz mains supply.
- For vegetable-based **liquid soap** with a maximum viscosity of 3,000 mPa.s or **specialist foam soap.**
- Models with tank: compatible with hydroalcoholic gel.
- Spout length: 115mm.
- 30-year warranty. CE marked.

For mixers and taps see DELABIE's "Water Controls for Public & Commercial Places" (DOC 609 INT) catalogue.

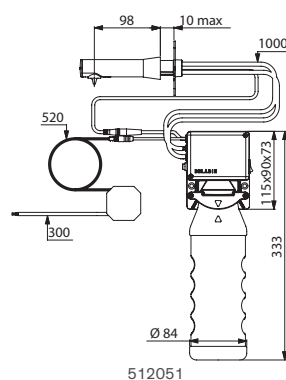
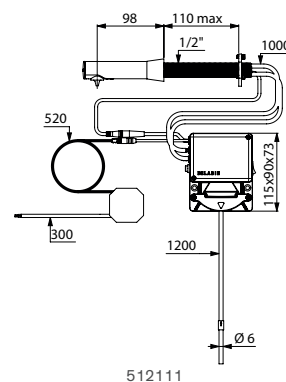

<b>BINOPTIC electronic liquid or foam soap dispenser - chrome-plated 304 stainless steel</b>	
Wall-mounted, with 1 litre tank	<b>512051P</b>
Wall-mounted, with 1.20m flexible tube for remote tanks	<b>512151P</b>
Cross wall, with 1.20m flexible tube for remote tanks	<b>512111P</b>
<b>BINOPTIC electronic liquid or foam soap dispenser - satin finish 304 stainless steel</b>	
Wall-mounted, with 1 litre tank	<b>512051S</b>
Wall-mounted, with 1.20m flexible tube for remote tanks	<b>512151S</b>
Cross wall, with 1.20m flexible tube for remote tanks	<b>512111S</b>
<b>BINOPTIC electronic liquid or foam soap dispenser - matte black 304 stainless steel</b>	
Wall-mounted, with 1 litre tank	<b>512051BK</b>
Wall-mounted, with 1.20m flexible tube for remote tanks	<b>512151BK</b>
Cross wall, with 1.20m flexible tube for remote tanks	<b>512111BK</b>



### BINOPTIC electronic soap dispenser

Deck-mounted, mains supply



- **No manual contact:** infrared cell detects hands automatically.
- Chrome-plated, satin finish or matte black 304 stainless steel spout.
- **No waste dose dispenser.**
- Independent electronic housing and removable tank enable installation beneath the washbasin.
- 100-240V / 50-60 Hz mains supply.
- For vegetable-based **liquid soap** with maximum viscosity of 3,000 mPa.s or **specific foam soap**.
- Models with tank: compatible with hydroalcoholic gel.
- CE marked. 30-year warranty.

For mixers and taps see DELABIE's catalogue "Water Controls for Public & Commercial Places" catalogue (DOC 609 INT).

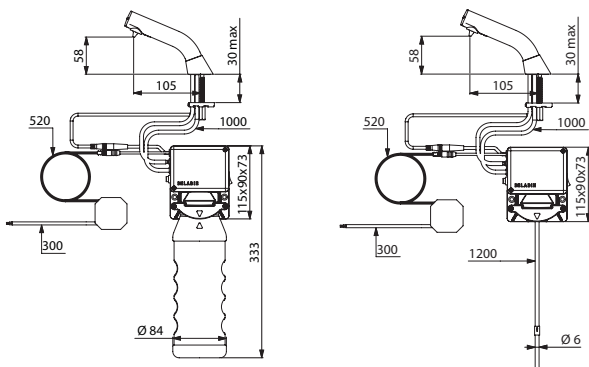

512021

512121

#### BINOPTIC deck-mounted electronic liquid or foam soap dispenser, mains supply - chrome-plated 304 stainless steel

With 1 litre tank	<b>512021P</b>
With 0.5 litre tank	<b>512521P</b>
With 1.20m flexible tube for remote tanks	<b>512121P</b>

#### BINOPTIC deck-mounted electronic liquid or foam soap dispenser, mains supply - satin finish 304 stainless steel

With 1 litre tank	<b>512021S</b>
With 0.5 litre tank	<b>512521S</b>
With 1.20m flexible tube for remote tanks	<b>512121S</b>

#### BINOPTIC deck-mounted electronic liquid or foam soap dispenser, mains supply - matte black 304 stainless steel

With 1 litre tank	<b>512021BK</b>
With 0.5 litre tank	<b>512521BK</b>
With 1.20m flexible tube for remote tanks	<b>512121BK</b>

### TEMPOMATIC 4 electronic soap dispenser

Deck-mounted, mains supply or battery-operated



- **No manual contact:** infrared cell detects hands automatically.
- Chrome-plated 304 stainless steel spout.
- **No waste dose dispenser.**
- Independent electronic housing and removable tank enable installation beneath the washbasin.
- 100-240V / 50-60 Hz mains supply or battery-operated.
- For vegetable-based **liquid soap** with maximum viscosity of 3,000 mPa.s or **specific foam soap**.
- Models with tank: compatible with hydroalcoholic gel.
- CE marked. 30-year warranty.

For mixers and taps see DELABIE's catalogue "Water Controls for Public & Commercial Places" catalogue (DOC 609 INT).

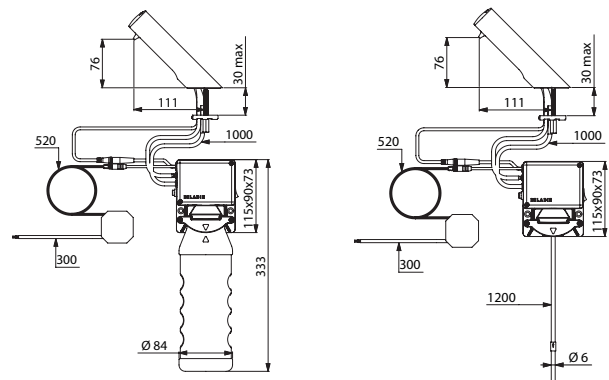

512031P

512131P

Provisional availability for battery-operated models: 1<sup>st</sup> half 2024. Please contact sales office to check availability.

#### TEMPOMATIC 4 deck-mounted electronic liquid or foam soap dispenser, mains supply chrome-plated 304 stainless steel

With 1 litre tank	<b>512031P</b>
With 0.5 litre tank	<b>512531P</b>
With 1.20m flexible tube for remote tanks	<b>512131P</b>

#### TEMPOMATIC 4 deck-mounted electronic liquid or foam soap dispenser, battery-operated chrome-plated 304 stainless steel

With 1 litre tank	<b>512036P</b>
With 1.20m flexible tube for remote tanks	<b>512136P</b>



Matte black wall-mounted electronic liquid soap dispenser **512066BK** - BLACK BINOPTIC matte black electronic basin tap **388035**

**Electronic liquid soap dispenser**  
Wall-mounted, **battery-operated**



Bright polished 304 stainless steel and matte black powder-coated, 1-litre model

- **Vandal-resistant model with lock and standard DELABIE key.**
- **No manual contact:** hands are automatically detected by infrared cell (detection distance can be adjusted).
- **Bacteriostatic 304 stainless steel** cover.
- **One-piece hinged cover** for easy maintenance and better hygiene.
- **No waste pump dispenser:** dispenses 0.8ml (can be adjusted up to 7 doses per activation).
- Option of operation in **anti-clogging mode.**
- Power supply: 6 AA -1.5V (DC9V) batteries supplied integrated in the soap dispenser body.
- Low battery indicator light.
- Tank with large opening: easy to refill soap from large containers.
- Window allows soap level to be checked.
- Stainless steel thickness: 1mm.
- Capacity: 0.5 or 1 litre.
- For vegetable-based liquid soap with a maximum viscosity of 3,000 mPa.s.
- Compatible with hydroalcoholic gel.
- 30-year warranty.
- CE marked.

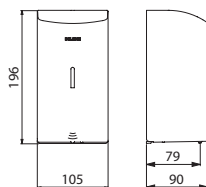

512566

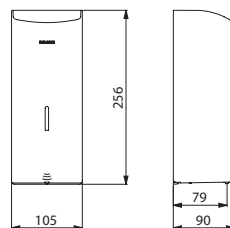

512066



Polished satin 304 stainless steel, 0,5-litre model



White powder-coated 304 st. steel, 0,5-litre model

**Related product**



**Drip tray**

- Bacteriostatic 304 stainless steel.
- Drip tray suitable for collecting residual gel.
- For soap dispensers 51058... and 512066...
- 30-year warranty.

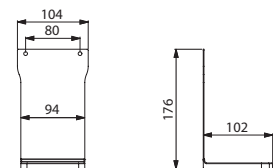

512067

<b>Electronic liquid soap dispenser - 0.5 litre</b>	
Bright polished 304 stainless steel	<b>512566P</b>
Polished satin 304 stainless steel	<b>512566S</b>
White powder-coated 304 stainless steel	<b>512566W</b>
Matte black powder-coated 304 stainless steel	<b>512566BK</b>
<b>Electronic liquid soap dispenser - 1 litre</b>	
Bright polished 304 stainless steel	<b>512066P</b>
Polished satin 304 stainless steel	<b>512066S</b>
White powder-coated 304 stainless steel	<b>512066W</b>
Matte black powder-coated 304 stainless steel	<b>512066BK</b>

<b>Drip tray for hydroalcoholic gel</b>	
Bright polished 304 stainless steel	<b>512067P</b>
Polished satin 304 stainless steel	<b>512067S</b>
White powder 304 stainless steel	<b>512067W</b>
Black powder 304 stainless steel	<b>512067BK</b>





**Liquid soap dispenser with soft-touch operation**

Wall-mounted



Bright polished 304 stainless steel, 1-litre model



Polished satin 304 stainless steel, 0.5-litre model



White powder-coated 304 stainless steel, 0.5-litre model

- **Vandal-resistant model with lock and standard DELABIE key.**
- **Bacteriostatic 304 stainless steel** cover.
- **One-piece hinged cover** for easy maintenance and better hygiene.
- **Push-button with soft-touch operation.**
- **Anti-blocking:** single dose per press even when the button is pressed for long periods.
- No waste, non-drip (waterproof) pump-action dispenser.
- Tank with large opening: easy to refill soap from large containers.
- Tank prevents long-term stagnation of soap.
- Window allows soap level to be checked.
- Stainless steel thickness: 1mm.
- Capacity: 0.5 or 1 litre.
- 0.5-litre model dimensions: 90 × 105 × 185mm.
- 1-litre model dimensions: 90 × 105 × 252mm.
- For vegetable-based liquid soap with a maximum viscosity of 3,000 mPa.s.
- Compatible with hydroalcoholic gel.
- 30-year warranty.

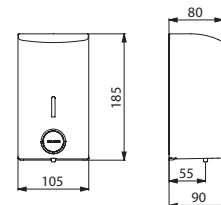

510583/510586/510584

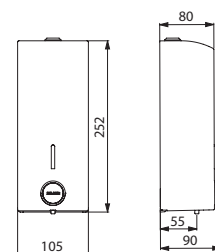

510580/510582/510581

Liquid soap dispenser with soft-touch operation - 0.5 litre	
Bright polished 304 stainless steel	<b>510583</b>
Polished satin 304 stainless steel	<b>510586</b>
White powder-coated 304 stainless steel	<b>510584</b>
Liquid soap dispenser with soft-touch operation - 1 litre	
Bright polished 304 stainless steel	<b>510580</b>
Polished satin 304 stainless steel	<b>510582</b>
White powder-coated 304 stainless steel	<b>510581</b>

## Cross wall liquid soap dispenser

Wall-mounted for cross wall installation

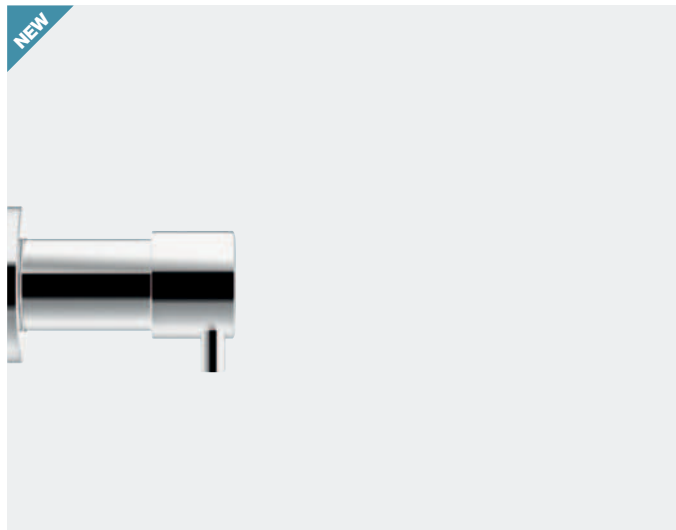

- **Vandal-resistant model for cross wall installation** for walls up to 190mm.
- **Bright polished 304 stainless steel** body and push-button.
- Non-drip system (waterproof).
- Supplied with a 1.20m flexible tube **for remote tanks** (supplied without a tank).
- 30-year warranty.

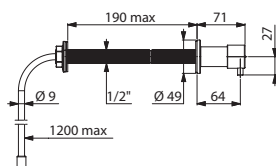

729170

Provisional availability 1<sup>st</sup> half 2024.  
Please contact sales office to check availability.

Cross-wall liquid soap dispenser for remote tank	729170
--	--------

## Liquid soap dispenser

Deck-mounted

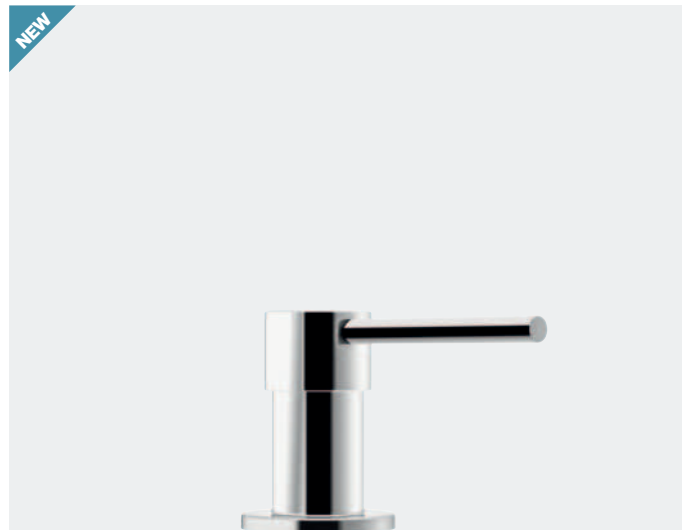

- Deck-mounted model.
- **Vandal-resistant model.**
- **Bright polished 304 stainless steel** body and push-button.
- Non-drip system (waterproof).
- **Discreet locking mechanism:** unlocking without special tools and automatic locking.
- Models with tank: compatible with hydroalcoholic gel; filling from the top (by unlocking the mechanism) or from the bottom (by removing the tank).
- 30-year warranty.

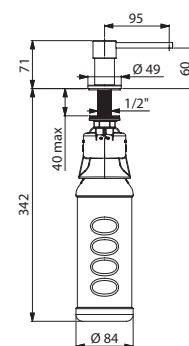

729064

Provisional availability 1<sup>st</sup> half 2024.  
Please contact sales office to check availability.

Deck-mounted liquid soap dispenser	
With 1 litre tank	729064
With 0.5 litre tank	729564
With a 1.20m flexible tube for remote tank (not supplied)	729164

**Soap dish**

304 stainless steel, wall-mounted



- **Robust model.**
- For showers or washbasins.
- **Bacteriostatic 304 stainless steel.**
- Stainless steel thickness: 1.5mm.
- **Concealed fixings.**
- 30-year warranty.

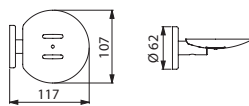

510627

Stainless steel soap dish	
Bright polished 304 stainless steel	<b>510627P</b>
Polished satin 304 stainless steel	<b>510627S</b>

**Wire soap basket for showers**

Stainless steel, wall-mounted

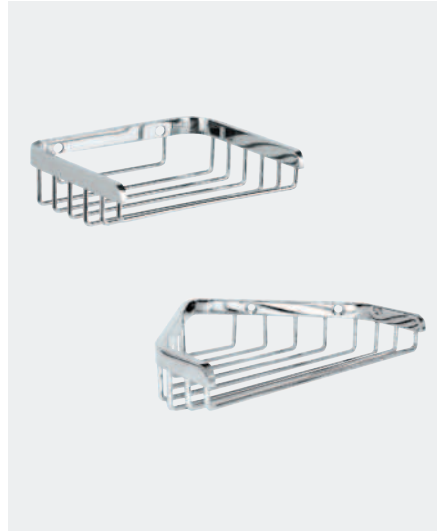

- **Robust model.**
- Bright polished stainless steel.
- Rectangular model dimensions: 100 × 130 × 34mm.
- Corner model dimensions: 120 × 165 × 34mm.
- 30-year warranty.

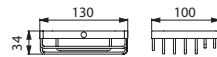

569

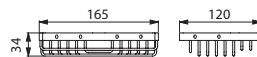

3569

Bright polished stainless steel wire soap basket	
Rectangular	<b>569</b>
Corner	<b>3569</b>

**Soap dish**

Wall-mounted



- **Robust model.**
- **Concealed fixings.**
- Dimensions: 60 × 160 × 40mm.
- 30-year warranty.

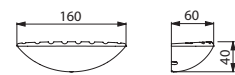

710501/710500

Soap dish	
Bright chrome-plated Bayblend®	<b>710501</b>
Matte chrome-plated Bayblend®	<b>710500</b>

**Twin toilet roll holder**

304 stainless steel

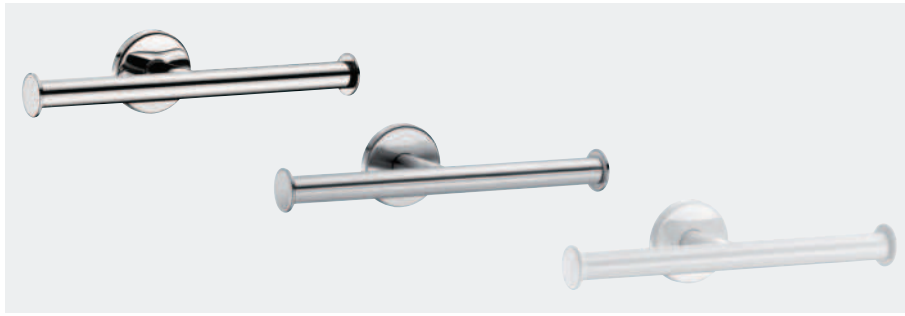

- **Bacteriostatic 304 stainless steel.**
- For two toilet rolls.
- Tube Ø 20mm, 1mm thick.
- **Concealed fixings.**
- 30-year warranty.

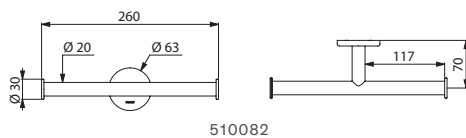

Twin toilet roll holder	
Bright polished 304 stainless steel	<b>510082P</b>
Polished satin 304 stainless steel	<b>510082S</b>
White powder-coated 304 stainless steel	<b>510082W</b>

**U-shaped toilet roll holder**

304 stainless steel



- **Bacteriostatic 304 stainless steel.**
- Tube Ø 20mm, 1mm thick.
- **Concealed fixings.**
- 30-year warranty.

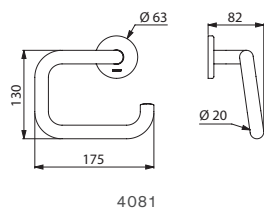

U-shaped toilet roll holder	
Bright polished 304 stainless steel	<b>4081P</b>
Polished satin 304 stainless steel	<b>4081S</b>
White powder-coated 304 stainless steel	<b>4081EW</b>

**Toilet roll holder**

Or for spares, 304 stainless steel

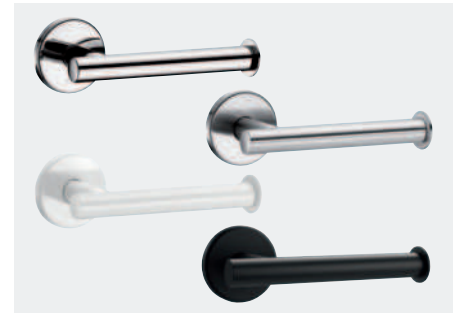

- **Bacteriostatic 304 stainless steel.**
- Can be installed horizontally for **main use**, or vertically as a **spare toilet roll holder**.
- Tube Ø 20mm, 1mm thick.
- **Concealed fixings.**
- 30-year warranty.

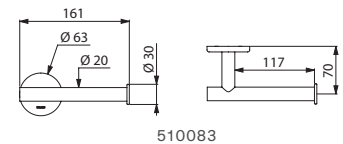

Toilet roll holder	
Bright polished 304 stainless steel	<b>510083P</b>
Polished satin 304 stainless steel	<b>510083S</b>
White powder 304 stainless steel	<b>510083W</b>
Black powder 304 stainless steel	<b>510083BK</b>

**U-shaped toilet roll holder**

Nylon



- **High-strength polyamide (Nylon).**
- Tube Ø 20mm.
- **Concealed fixings.**
- 30-year warranty.

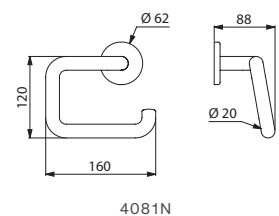

U-shaped toilet roll holder	
Bright white HR Nylon	<b>4081N</b>

### Toilet roll holder

For spares, 304 stainless steel

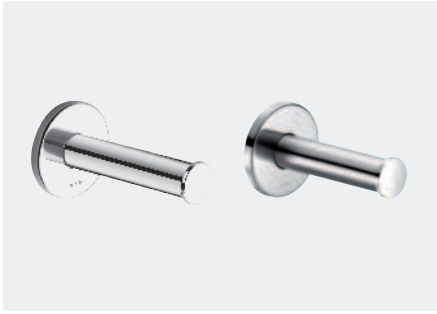

- **Bacteriostatic 304 stainless steel.**
- Tube Ø 25mm, 1.2mm thick.
- **Concealed fixings.**
- 30-year warranty.

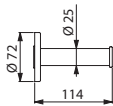

4070

#### Spare toilet roll holder

Bright polished 304 stainless steel	<b>4070P</b>
Polished satin 304 stainless steel	<b>4070S</b>

### Toilet roll holder with one-piece cover

304 stainless steel, anti-theft

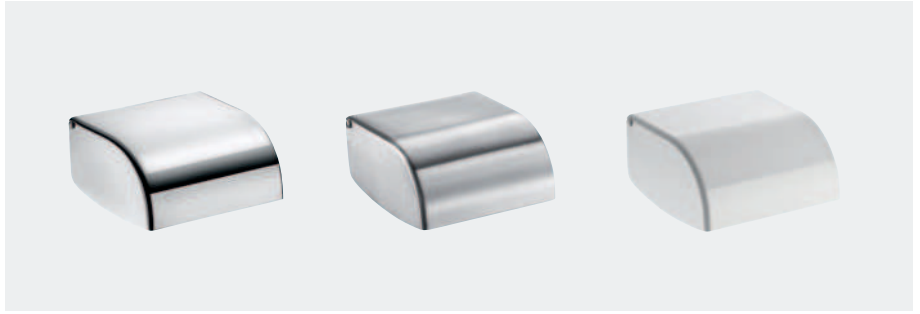

- **Bacteriostatic 304 stainless steel.**
- **One-piece hinged cover** for easy maintenance and better hygiene.
- Anti-theft, unbreakable, integral polycarbonate spindle.
- **Concealed fixings.**
- Dimensions: 119 × 140 × 80mm.
- 30-year warranty.

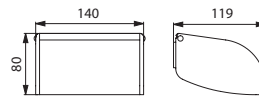

566/510567/3565

#### Toilet roll holder with one-piece cover

Bright polished 304 stainless steel	<b>566</b>
Polished satin 304 stainless steel	<b>510567</b>
White powder-coated 304 stainless steel	<b>3565</b>

### Toilet roll holder

For spares, Nylon



- **High-strength polyamide (Nylon).**
- Tube Ø 32mm.
- **Concealed fixings.**
- 30-year warranty.

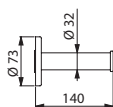

4070N

#### Spare toilet roll holder Bright white HR Nylon

**4070N**

### Toilet paper dispenser for 2 rolls

304 stainless steel



- **Vandal-resistant robust model.**
- **Bacteriostatic 304 stainless steel.**
- 1 spare roll.
- With lock and **standard DELABIE key.**
- Level control.
- Stainless steel thickness: 1mm.
- Dimensions: 130 × 120 × 260mm.
- 30-year warranty.

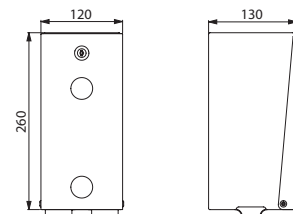

1660/1661

#### Toilet paper dispenser for 2 rolls

Bright polished 304 stainless steel	<b>1660</b>
Polished satin 304 stainless steel	<b>1660S</b>
White powder-coated 304 stainless steel	<b>1661</b>



Wall-hung S21 S WC pan **110310** - TEMPOFIX 3 frame system with TEMPOFLUX 2 time flow direct flush valve **578305+578222** - Toilet brush set **4051S**  
Toilet paper dispenser **2912** - Coat hook **4043P** - CANAL wash trough **120280** - TEMPOSOFT 2 time flow tap **741550** - Soap dispenser **510582**

### Large toilet paper dispenser

For rolls



- **Model for rolls.**
- **One-piece hinged cover** for easy maintenance and better hygiene.
- With lock and **standard DELABIE key.**
- **With back-piece:** protects the paper from wall imperfections, damp and dust.
- Level control.
- 30-year warranty.

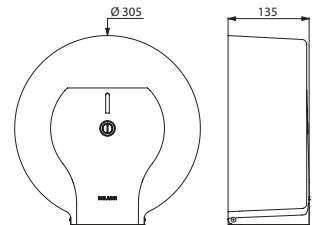

2911/2912/2910

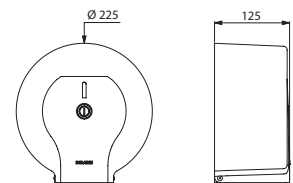

2901/2902/2900

Large toilet paper dispenser for 400m rolls	
Bright polished 304 stainless steel	<b>2911</b>
Polished satin 304 stainless steel	<b>2912</b>
White lacquered steel	<b>2910</b>
Large toilet paper dispenser for 200m rolls	
Bright polished 304 stainless steel	<b>2901</b>
Polished satin 304 stainless steel	<b>2902</b>
White lacquered steel	<b>2900</b>

### Large toilet paper dispenser

For rolls

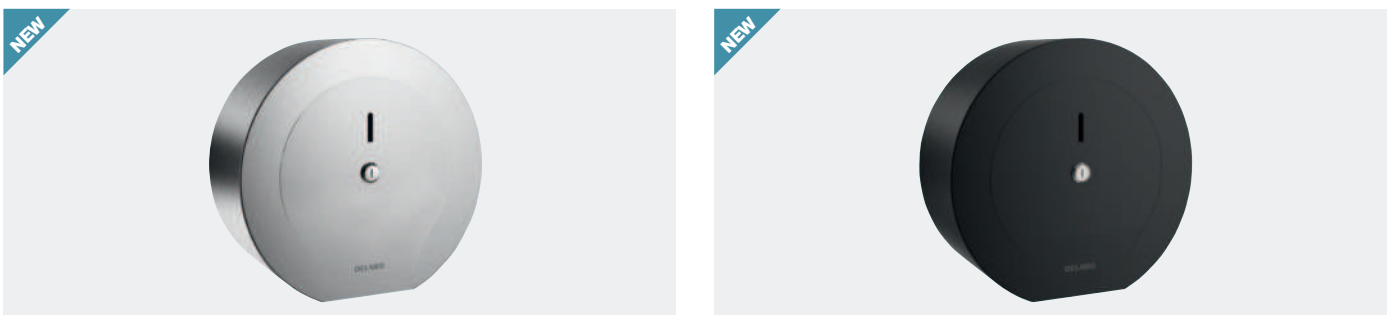

- **Model for rolls.**
- **One-piece hinged cover** for easy maintenance and better hygiene.
- With lock and **standard DELABIE key.**
- **With back-piece:** protects the paper from wall imperfections, damp and dust.
- Level control.
- 30-year warranty.

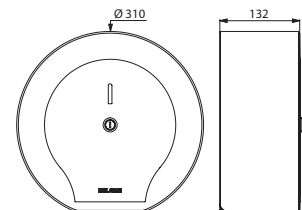

510910

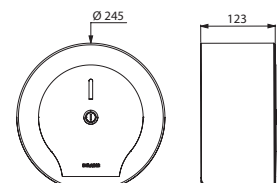

510911

Large toilet paper dispenser for 400m rolls	
Polished satin 304 stainless steel	<b>510910S</b>
Matte black powder-coated 304 stainless steel	<b>510910BK</b>
Large toilet paper dispenser for 200m rolls	
Polished satin 304 stainless steel	<b>510911S</b>
Matte black powder-coated 304 stainless steel	<b>510911BK</b>



Toilet brush set WC 4051S - TEMPOFIX 3 frame system with TEMPOFLUX 2 time flow direct flush valve 578305+578222 - Wall-hung S21 S WC pan 110310



Toilet brush set



Bright polished and matte black 304 stainless steel, model with lid



Polished satin 304 stainless steel, model without lid

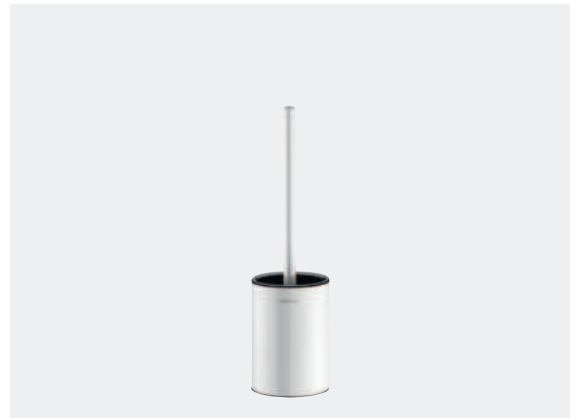

White powder-coated 304 stainless steel, model without lid

- **Robust model.**
- **Bacteriostatic 304 stainless steel.**
- Wall-mounted or floor-standing.
- **Ergonomic handle extension possible:** easy for wheelchair users or those with difficulty bending to use.
- Easy to clean: plastic bowl can be removed from above.
- **Plastic bowl with reservoir:** prevents toilet brush sitting in residual water and reduces the risk of splashing when next used.
- Model with lid: toilet brush **automatically centres itself** in the holder.
- **Anti-theft lock** (wall-mounted model).
- Stainless steel thickness: 1mm body.
- 30-year warranty.

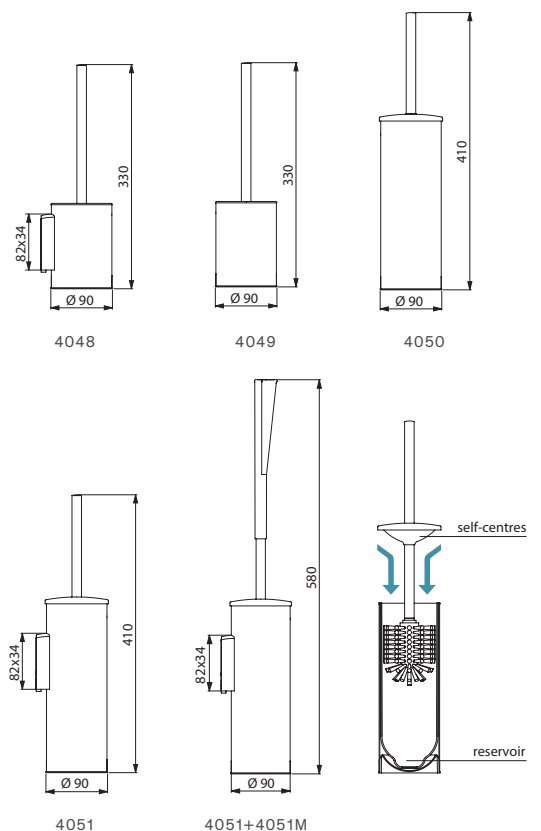

<b>Wall-mounted toilet brush set without lid - Anti-theft lock</b>	
Bright polished 304 stainless steel	<b>4048P</b>
Polished satin 304 stainless steel	<b>4048S</b>
White powder-coated 304 stainless steel	<b>4048EW</b>
<b>Floor-standing toilet brush set without lid</b>	
Bright polished 304 stainless steel	<b>4049P</b>
Polished satin 304 stainless steel	<b>4049S</b>
<b>Wall-mounted toilet brush set with lid - Anti-theft lock</b>	
Bright polished 304 stainless steel	<b>4051P</b>
Polished satin 304 stainless steel	<b>4051S</b>
White powder-coated 304 stainless steel	<b>4051EW</b>
Matte black powder-coated 304 stainless steel	<b>4051BK</b>
<b>Floor-standing toilet brush set with lid</b>	
Bright polished 304 stainless steel	<b>4050P</b>
Polished satin 304 stainless steel	<b>4050S</b>
<b>Ergonomic extension for toilet brush handle</b>	
	<b>4051M</b>

### Toilet brush set With long handle



- **High-strength polyamide (Nylon).**
- **Long, ergonomic handle:** easy for wheelchair users or people who have difficulty bending to use.
- Easy to clean: plastic bowl can be removed from above.
- **Plastic bowl with reservoir:** prevents toilet brush sitting in residual water and reduces the risk of splashing when next used.
- Wall-mounted with **anti-theft lock.**
- Height 515mm.
- 30-year warranty.

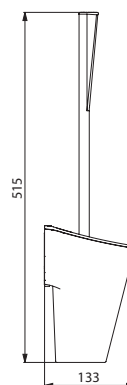

4051N

Toilet brush set, bright white HR Nylon - with long handle - Anti-theft lock	4051N
--	-------

**Hygienic bag dispenser and bin**



- Bin with flap on top.
- Hygienic bag dispenser beneath.
- Capacity: 9 litres.
- Hinged cover with lock and **standard DELABIE key**.
- Wall-mounted.
- Stainless steel thickness: 1mm.
- Dimensions: 123 × 250 × 350mm.
- 30-year warranty.

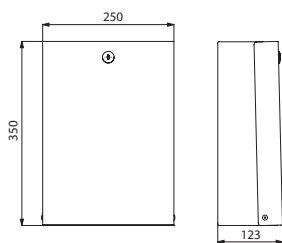

2561D/2561DS

Hygienic bag dispenser & bin	
Bright polished 304 stainless steel	<b>2561D</b>
Polished satin 304 stainless steel	<b>2561DS</b>

**Changing table**



- Wall-mounted model.
- With **adjustable strap**, adapts perfectly to the shape of the newly changed baby.
- For babies up to 11kg or 12 months.
- High density polyethylene (HDPE).
- Space saving: retained in the vertical position.
- **Slowed down descent**.
- Easy to maintain: surface is easy to clean.
- Complies with European standard EN 12221.
- Dimensions: open position 855 × 585 × 495mm, closed position 855 × 585 × 107mm.
- Changing table weight: 11.5kg.
- 30-year warranty.

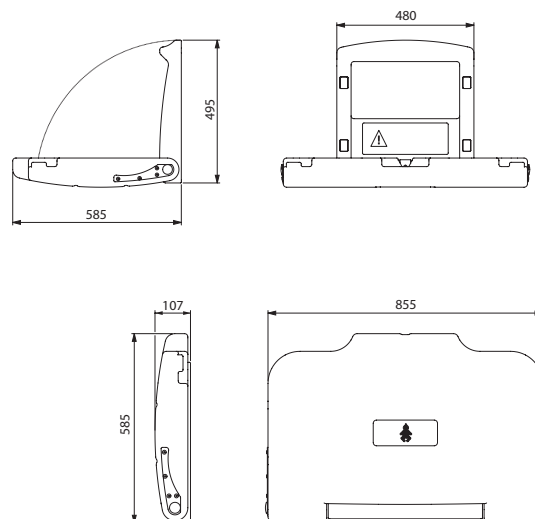

510700

<b>Changing table</b>	<b>510700</b>
-----------------------	---------------



Tilting mirror with tab handle **510202P** - Towel rail with 2 rails **510790P** - Double coat hook **4042P** - Soap dish **510627P**  
MINERALCAST PMR washbasin **132306** - Sequential thermostatic mixer **H9600**

### Tilting glass mirror

With long, ergonomic lever



- **For combined installation:** can be used from sitting or standing position.
- **Long, ergonomic lever for easy adjustment of mirror angle from a sitting position or from a wheelchair.**
- **Quick and easy to install:** just clip into place.
- **Anti-theft lock.**
- Bright white HR Nylon lever.
- Mirror made from 6mm laminated safety glass.
- Can be tilted up to 20°.
- Mirror dimensions: 500 × 600mm.
- 30-year warranty.

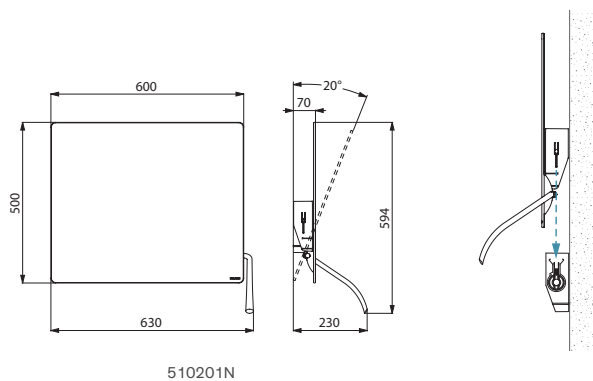

### Tilting glass mirror

With tab handle



- **For combined installation:** can be used from sitting or standing position.
- **Tab handle for easy adjustment of mirror angle for those in a sitting position or for wheelchair users.**
- **Quick and easy to install:** just clip into place.
- **Anti-theft lock.**
- Mirror made from 6mm laminated safety glass.
- Can be tilted up to 20°.
- Mirror dimensions: 500 × 600mm.
- 30-year warranty.

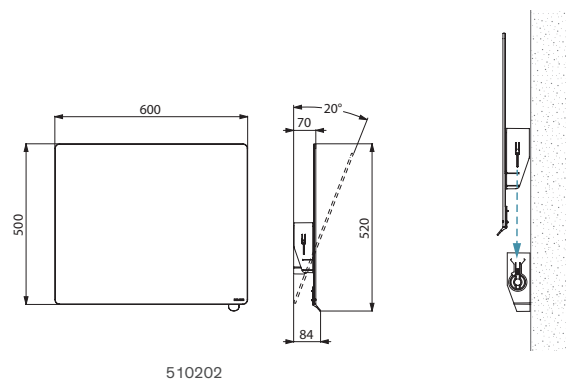

#### Glass mirror - With tab handle for tilting

Chrome-plated bright tab handle	<b>510202P</b>
Chrome-plated satin tab handle	<b>510202S</b>
Metallised anthracite tab handle	<b>510202C</b>
White Nylon tab handle	<b>510202N</b>

Glass mirror - With long, ergonomic lever for tilting	<b>510201N</b>
---	----------------

**Glass mirror**



- 6mm thick.
- Individually packaged.
- Order mounting brackets separately.
- 3451 model dimensions: 6 × 360 × 480mm.
- 3450 model dimensions: 6 × 420 × 600mm.
- 3454 model dimensions: 6 × 500 × 750mm.
- 30-year warranty.

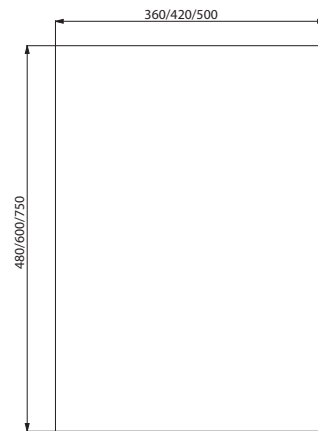

3451/3450/3454

Glass mirror	
360 × 480mm	3451
420 × 600mm	3450
500 × 750mm	3454

**Round studded pegs**

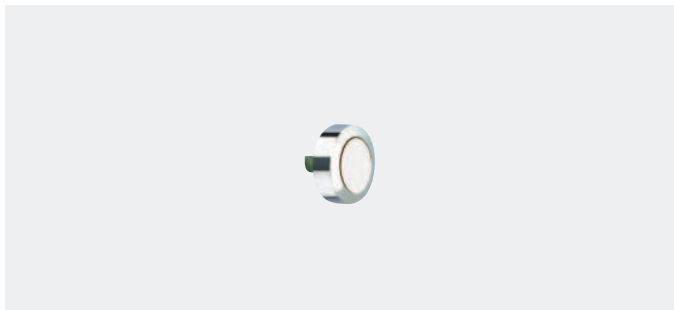

- Chrome-plated brass.
- Screw in.
- Dimensions: Ø 20mm.
- 30-year warranty.



578

**Studded pegs with a spring**

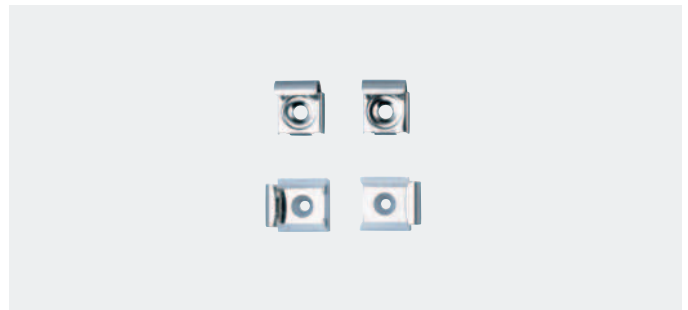

- Pack of 4 mounting pegs, 2 of which incorporate a spring.
- Bright polished stainless steel.
- 30-year warranty.

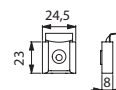

577

Round studded pegs	578
--------------------	-----

Pack of 4 studded pegs, 2 of which have springs	577
---	-----

**Stainless steel mirror**  
Self-adhesive - H. 600mm



- **"Mirror" polished** bacteriostatic 304 stainless steel.
- Stainless steel thickness: 1mm.
- **Unbreakable.**
- For installation on a flat surface.
- Self-adhesive.
- Dimensions: 1 × 400 × 600mm.
- 30-year warranty.

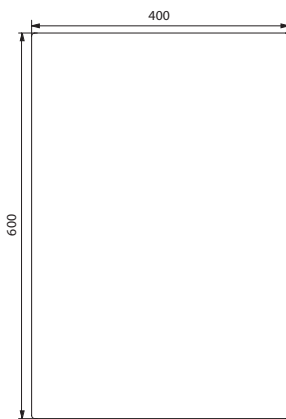

3453

**Stainless steel mirror**  
Concealed fixings - H. 500/600/1,000mm



- **"Mirror" polished** bacteriostatic 304 stainless steel.
- **Reinforced by a concealed solid PVC plate** 10mm thick.
- 5 fixing points. Concealed fixings.
- **Unbreakable.**
- For installation on a flat surface.
- Model 3459: **for combined installation, height enables use from standing or sitting positions, or from a wheelchair.**
- 3452 model dimensions: 10 × 385 × 485mm.
- 3458 model dimensions: 10 × 485 × 585mm.
- 3459 model dimensions: 10 × 595 × 980mm.
- 30-year warranty.

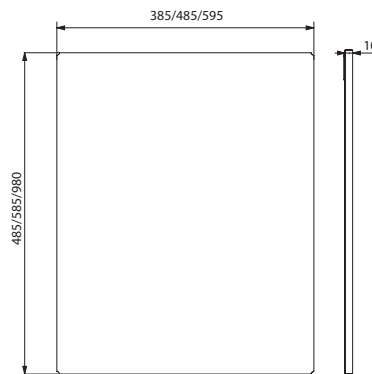

3452/3458/3459

Stainless steel mirror 1 × 400 × 600mm	3453
---	------

Stainless steel mirror - Concealed fixings	
10 × 385 × 485mm	3452
10 × 485 × 585mm	3458
10 × 595 × 980mm	3459

**Robe hook**

304 stainless steel, **1 hook**

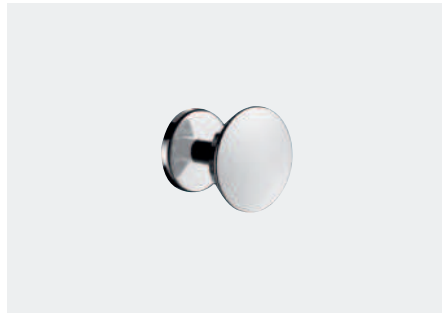

- **Concealed fixings.**
- Bright polished and chrome plated 304 stainless steel.
- Dimensions:  $\varnothing 65 \times 58$ mm.
- 30-year warranty.

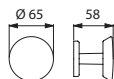

301

Robe hook, 1 hook	301
-------------------	-----

**Robe hooks**

304 stainless steel, **2 hooks**



- **Concealed fixings.**
- Bright polished and chrome plated 304 stainless steel.
- Dimensions :  $\varnothing 65 \times 215 \times 58$ mm.
- 30-year warranty.

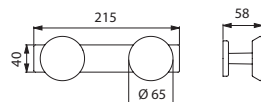

302

Robe hook, 2 hooks	302
--------------------	-----

**Robe hooks**

304 stainless steel, **3 hooks**



- **Concealed fixings.**
- Bright polished and chrome plated 304 stainless steel.
- Dimensions :  $\varnothing 65 \times 345 \times 58$ mm.
- 30-year warranty.

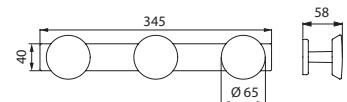

303D

Robe hook, 3 hooks	303D
--------------------	------

**Ligature-resistant hook**

304 stainless steel



- **Ligature-resistant:** the hook lowers with loads over 30kg.
- **Polished satin 304 stainless steel.**
- Dimensions:  $\varnothing 90 \times 68$ mm.
- 30-year warranty.

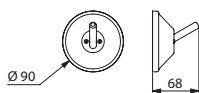

510104S

Ligature-resistant clothes hook 304 stainless steel	510104S
--	---------

**Hook**

304 stainless steel



- **Bright polished 304 stainless steel.**
- **Thickness: 2mm.**
- Dimensions:  $50 \times 25 \times 145$ mm.
- 30-year warranty.

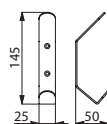

101P

304 stainless steel clothes hook	101P
----------------------------------	------

**Coat hook**

304 stainless steel



- **Bacteriostatic 304 stainless steel.**
- Dimensions:  $\varnothing 18 \times 40$ mm.
- **Concealed fixings.**
- 30-year warranty.



510047

Coat hook	
Bright polished 304 stainless steel	<b>510047P</b>
Polished satin 304 stainless steel	<b>510047S</b>
White powder-coated 304 stainless steel	<b>510047W</b>
Matte black powder-coated 304 stainless steel	<b>510047BK</b>



**Coat hook**

304 stainless steel



- **Bacteriostatic 304 stainless steel.**
- Tube Ø 20mm, 1mm thick.
- **Concealed fixings.**
- 30-year warranty.

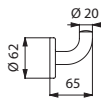

4043

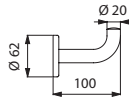

4047P

Coat hook - Short model	
Bright polished 304 stainless steel	<b>4043P</b>
Polished satin 304 stainless steel	<b>4043S</b>
White powder-coated 304 stainless steel	<b>4043EW</b>
Matte black powder-coated 304 stainless steel	<b>4043BK</b>
Coat hook - Long model - Bright polished 304 stainless steel	
	<b>4047P</b>

**Double coat hook**

304 stainless steel



- **Bacteriostatic 304 stainless steel.**
- Tube Ø 20mm, 1mm thick.
- **Concealed fixings.**
- Dimensions: Ø 62 × 55 × 95mm.
- 30-year warranty.

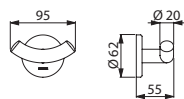

4042

Double coat hook	
Bright polished 304 stainless steel	<b>4042P</b>
Polished satin 304 stainless steel	<b>4042S</b>
White powder-coated 304 stainless steel	<b>4042W</b>

**Coat hook**

Nylon

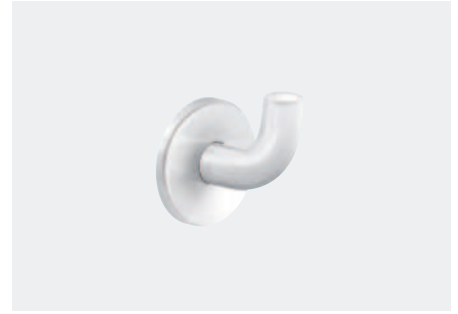

- **High-strength polyamide (Nylon).**
- Tube Ø 20mm.
- **Concealed fixings.**
- Dimensions: Ø 62 × 65 × 73mm.
- 30-year warranty.

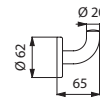

4043N

Coat hook - Bright white HR Nylon	
	<b>4043N</b>

**Coat hook**

Nylon

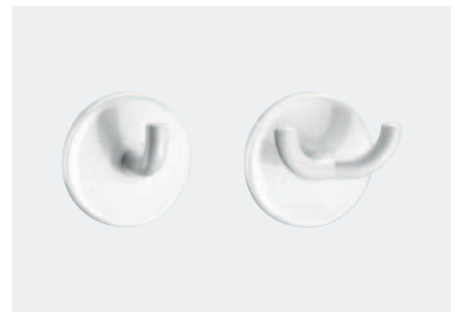

- **High-strength polyamide (Nylon).**
- Tube Ø 10mm.
- **Concealed fixings.**
- 30-year warranty.

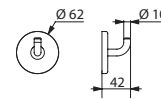

510043N

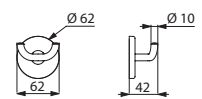

510042N

Coat hook bright white HR Nylon	
Single model	<b>510043N</b>
Double model	<b>510042N</b>

## DELABIE / Toilet signs

### Stainless steel toilet sign

Self-adhesive

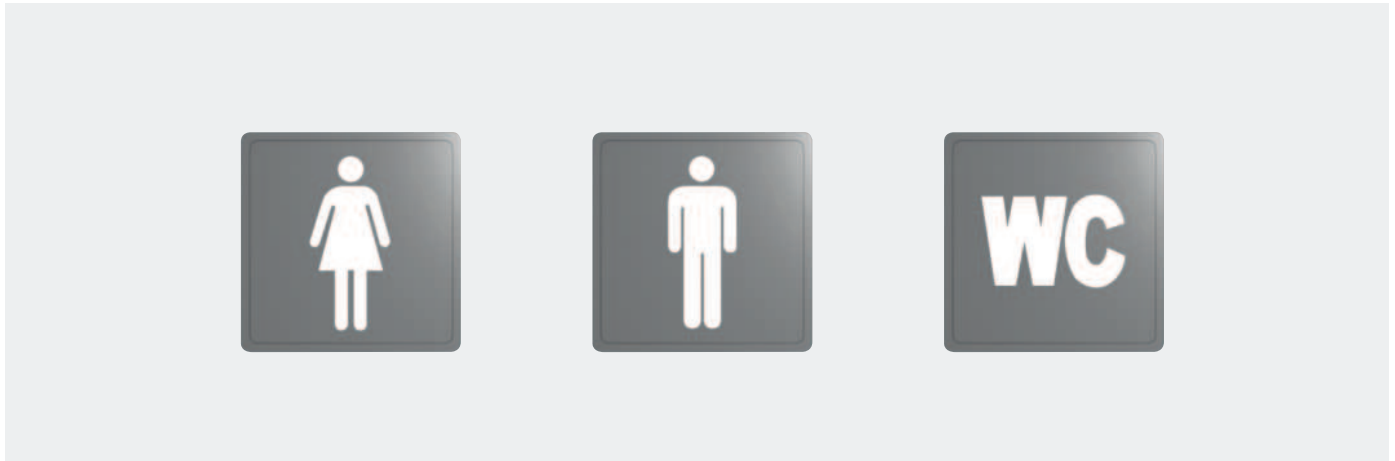

- Polished satin 304 stainless steel.
- Stainless steel thickness: 1.2mm.
- Dimensions: 125 × 125mm.
- 30-year warranty.

304 stainless steel toilet sign	
Female sign	510151S
Male sign	510152S
WC sign	510154S

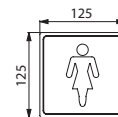

510151S

### Stainless steel "Disabled" signs

Self-adhesive

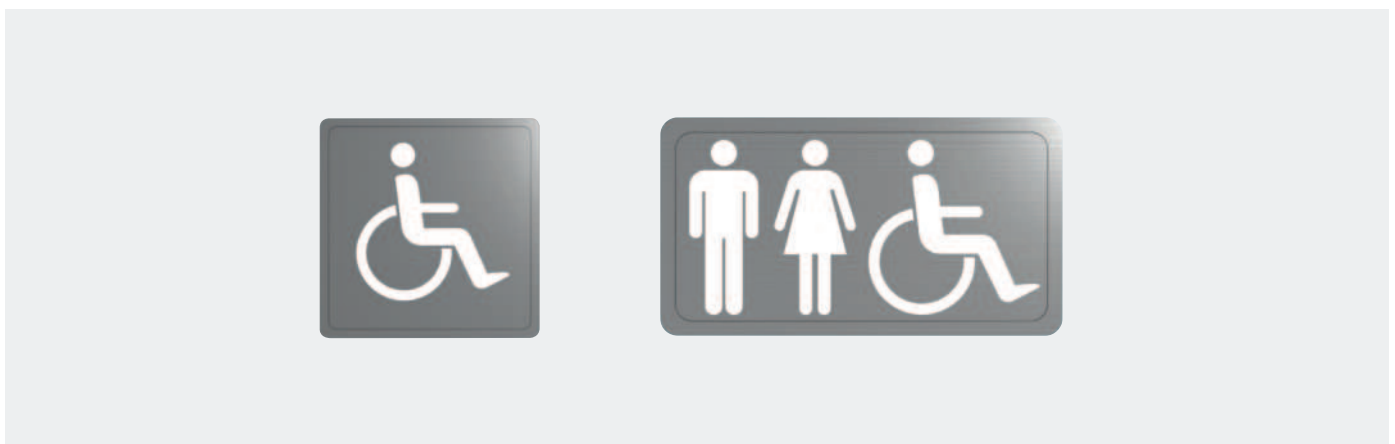

- Polished satin 304 stainless steel.
- Stainless steel thickness: 1.2mm.
- Dimensions: 125 or 230 × 125 mm.
- 30-year warranty.

304 stainless steel toilet sign	
Disabled sign	510153S
Mixed disabled sign	510155S

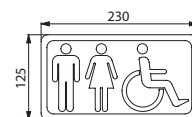

510155S

### Towel rail

Concealed fixings

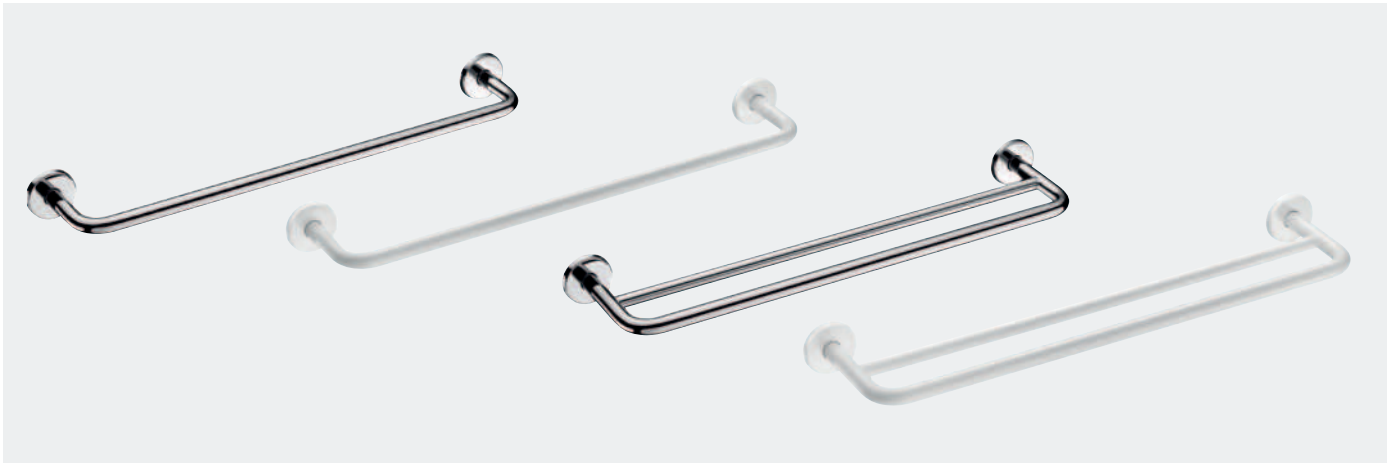

- **Robust model.**
- **Bacteriostatic 304 stainless steel.**
- $\varnothing$  20mm and  $\varnothing$  16mm tubes.
- **Concealed fixings.**
- Length 600mm.
- 30-year warranty.

Towel rail with concealed fixings - 1 rail	
Bright polished 304 stainless steel	<b>510788P</b>
Polished satin 304 stainless steel	<b>510788S</b>
White powder-coated 304 stainless steel	<b>510788W</b>
Towel rail with concealed fixings - 2 rails	
Bright polished 304 stainless steel	<b>510790P</b>
Polished satin 304 stainless steel	<b>510790S</b>
White powder-coated 304 stainless steel	<b>510790W</b>

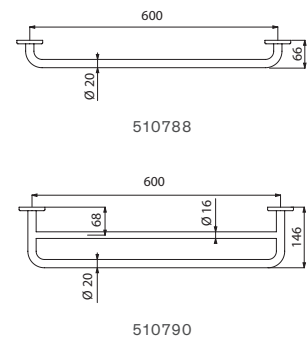

### Wall-mounted shelf

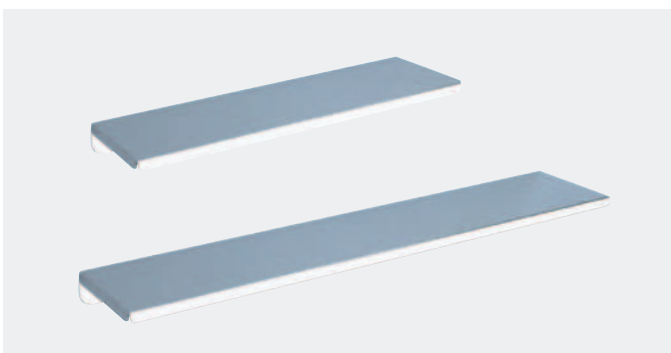

- 1mm thick.
- 30-year warranty.

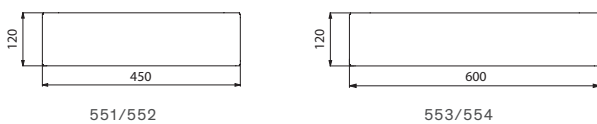

Bright polished 304 stainless steel shelf	
120 × 450mm	<b>551</b>
120 × 600mm	<b>553</b>
White powder-coated shelf	
120 × 450mm	<b>552</b>
120 × 600mm	<b>554</b>

### Glass shelf with supports

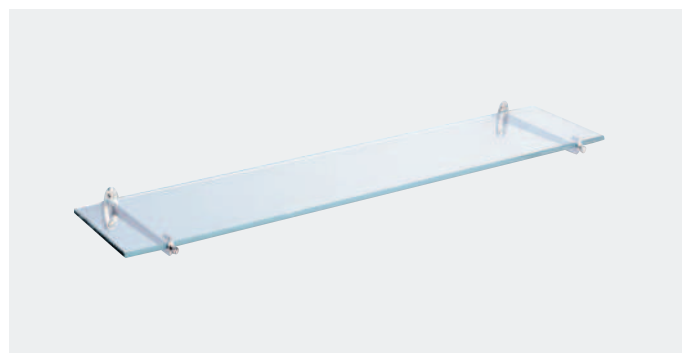

- Glass shelf with rounded edges, **6mm thick**, 120 × 600mm.
- 120mm chrome-plated shelf supports.
- 30-year warranty.

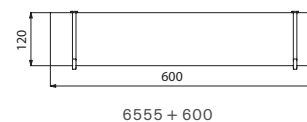

Basin shelf with supports	
Glass shelf	<b>6555</b>
Chrome-plated supports	<b>600</b>

**Satin finish Basic straight grab bar**

Tube Ø 32mm



- Polished satin 304 stainless steel.
- Concealed fixings, secured to wall by a 3-hole plate.
- 30-year warranty.
- CE marked.

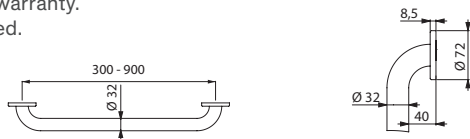

35050S/350504S/350505S/350506S/350508S/350509S

Basic straight grab bar Ø 32mm	
Polished satin 304 stainless steel - 300mm	<b>35050S</b>
Polished satin 304 stainless steel - 400mm	<b>350504S</b>
Polished satin 304 stainless steel - 500mm	<b>350505S</b>
Polished satin 304 stainless steel - 600mm	<b>350506S</b>
Polished satin 304 stainless steel - 800mm	<b>350508S</b>
Polished satin 304 stainless steel - 900mm	<b>350509S</b>

**Satin finish Basic angled grab bar 135°**

Tube Ø 32mm



- Polished satin 304 stainless steel.
- **3 fixing points prevent the hand from getting trapped and simplify installation.**
- Concealed fixings, secured to wall by a 3-hole plate.
- Dimensions: 400 × 400mm.
- 30-year warranty.
- CE marked.

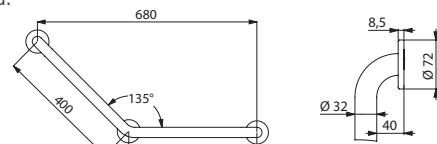

35082S

<b>Basic angled grab bar 135° Ø 32mm</b> Polished satin 304 stainless steel	<b>35082S</b>
--	---------------

**White powder-coated Basic straight grab bar**

Tube Ø 32mm



- White powder-coated stainless steel.
- Concealed fixings, secured to wall by a 3-hole plate.
- 30-year warranty.
- CE marked.

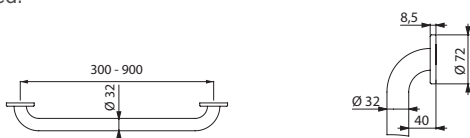

35050W/350504W/350505W/350506W

Basic straight grab bar Ø 32mm	
White powder-coated stainless steel - 300mm	<b>35050W</b>
White powder-coated stainless steel - 400mm	<b>350504W</b>
White powder-coated stainless steel - 500mm	<b>350505W</b>
White powder-coated stainless steel - 600mm	<b>350506W</b>

**White powder-coated Basic angled grab bar 135°**

Tube Ø 32mm



- White powder-coated stainless steel.
- **3 fixing points prevent the hand from getting trapped and simplify installation.**
- Concealed fixings, secured to wall by a 3-hole plate.
- Dimensions: 400 × 400mm.
- 30-year warranty.
- CE marked.

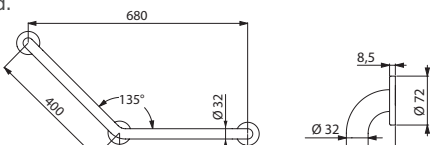

35082W

<b>Basic angled grab bar 135° Ø 32mm</b> White powder-coated stainless steel	<b>35082W</b>
---	---------------

**Bright ECO straight grab bar**

Tube Ø 25mm



- Bright polished 304 stainless steel.
- Visible fixings, secured to wall by a 3-hole plate.
- 30-year warranty.

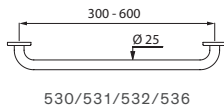

ECO straight grab bar Ø 25mm	
Bright polished 304 stainless steel - 300mm	530
Bright polished 304 stainless steel - 400mm	531
Bright polished 304 stainless steel - 500mm	532
Bright polished 304 stainless steel - 600mm	536

**Bright ECO angled grab bar 135°**

Tube Ø 25mm



- Bright polished 304 stainless steel.
- Visible fixings, secured to wall by a 3-hole plate.
- Dimensions: 220 × 220mm.
- 30-year warranty.

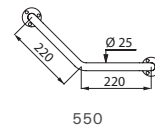

ECO angled grab bar 135° Ø 25mm Bright polished 304 stainless steel	550
--	-----

**White powder-coated ECO straight grab bar**

Tube Ø 25mm



- White powder-coated stainless steel.
- Visible fixings, secured to wall by a 3-hole plate.
- Dimensions: 300mm.
- 30-year warranty.

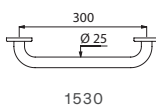

ECO straight grab bar Ø 25mm White powder-coated stainless steel - 300mm	1530
---	------

**White powder-coated ECO angled grab bar 135°**

Tube Ø 25mm



- White powder-coated stainless steel.
- Visible fixings, secured to wall by a 3-hole plate.
- Dimensions: 220 × 220mm.
- 30-year warranty.

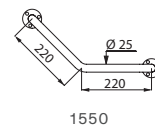

ECO angled grab bar 135° Ø 25mm White powder-coated stainless steel	1550
--	------

# DELABIE / Straight or angled shower curtain rail assembly kit

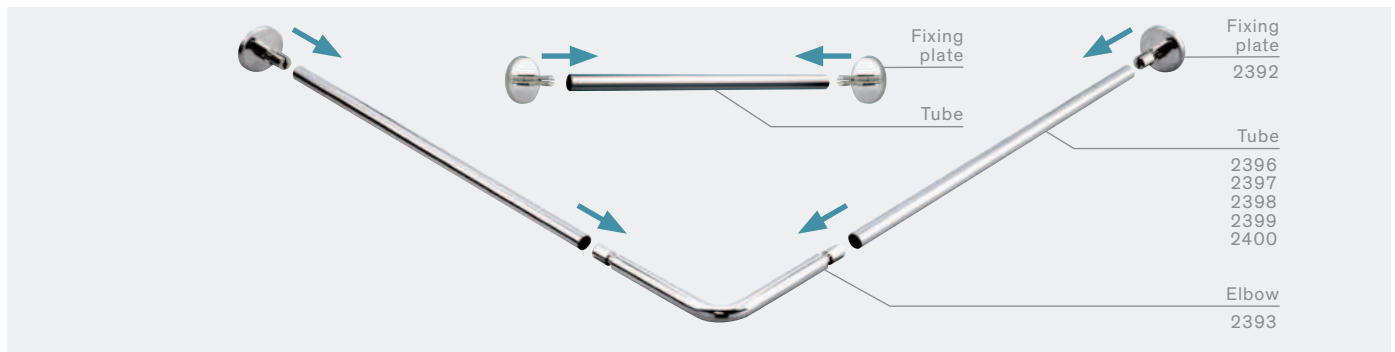

## Fixing plate

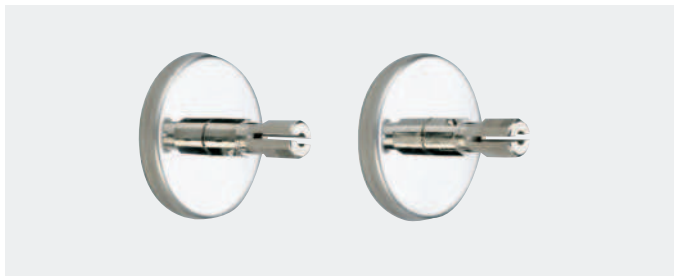

- For  $\varnothing$  20mm tubes.
- **Concealed fixings via 304 stainless steel plate.**
- With push-fit connectors for mounting.
- Supplied with 4 screws  $4 \times 30$ mm and 4 rawl plugs.
- 30-year warranty.

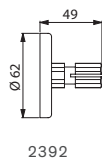

2392

Pack of 2 fixing plates	2392
-------------------------	------

## Sleeve connector



- To connect 2 straight tubes.
- Connects  $2 \times \varnothing$  20mm tubes.
- Dimensions:  $\varnothing$  18  $\times$  60mm.
- 30-year warranty.

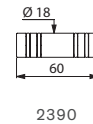

2390

Sleeve connector	2390
------------------	------

## Elbow connector



- To connect  $2 \times \varnothing$  20mm tubes.
- 304 stainless steel.
- With push-fit connectors for mounting.
- Dimensions:  $150 \times 150$ mm.
- 30-year warranty.

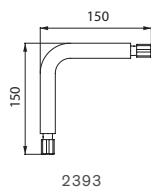

2393

Elbow connector	2393
-----------------	------

## Connecting tubes

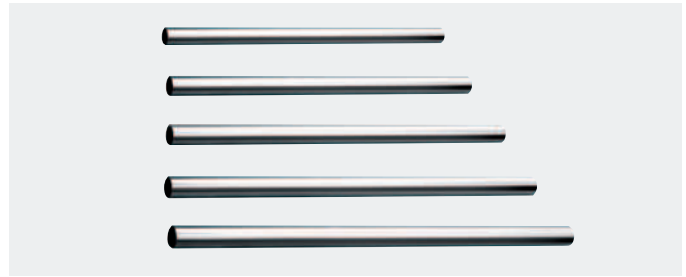

- Cut-to-size.
- Bright polished 304 stainless steel, 1mm thick.
- Tube  $\varnothing$  20mm.
- **Longer tubes available on request.**
- 30-year warranty.

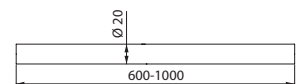

2396/2397/2398/2399/2400

Connecting tubes	
600mm	2396
700mm	2397
800mm	2398
900mm	2399
1,000mm	2400

### Cut-to-size straight curtain rail



- **Cut-to-size.**
- Bright polished 304 stainless steel.
- Tube Ø 16mm, 1mm thick.
- 30-year warranty.

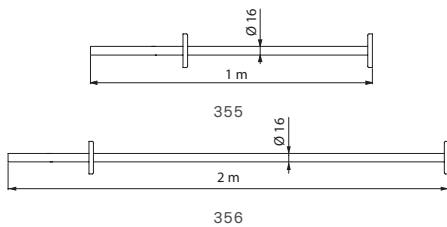

Straight curtain rail, cut-to-size	
Ø 16mm, 1m	<b>355</b>
Ø 16mm, 2m	<b>356</b>

See our ceiling supports for curtain rails on page 54.

### Cut-to-size straight curtain rail Concealed fixings



- **Cut-to-size.**
- Bright polished 304 stainless steel.
- **Concealed fixings.**
- Tube Ø 20mm, 1mm thick.
- 30-year warranty.

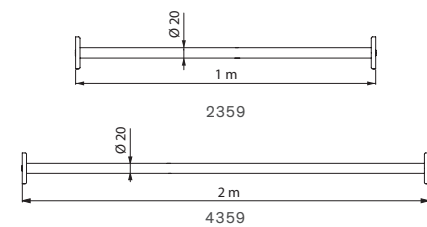

Straight curtain rail, cut-to-size - Concealed fixings	
Ø 20mm, 1m	<b>2359</b>
Ø 20mm, 2m	<b>4359</b>

See our ceiling supports for curtain rails on page 54.

### Adjustable straight curtain rail



- **Adjusts from 0.80m - 1.40m simply by rotating the tube.**
- Bright polished 304 stainless steel.
- Tube Ø 20mm, 1mm thick.
- 30-year warranty.

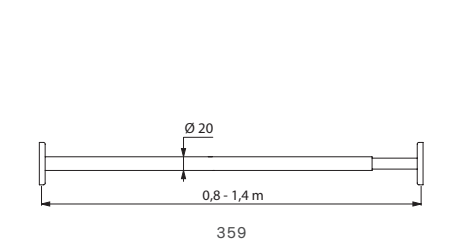

<b>Adjustable straight curtain rail Ø 20mm</b>	<b>359</b>
--	------------

See our ceiling supports for curtain rails on page 54.

### Telescopic, straight curtain rail ECO

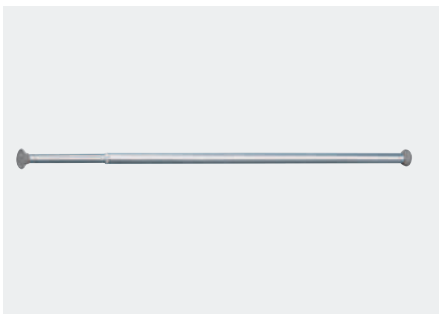

- **Telescopic.**
- Polished aluminium tube.
- 30-year warranty.

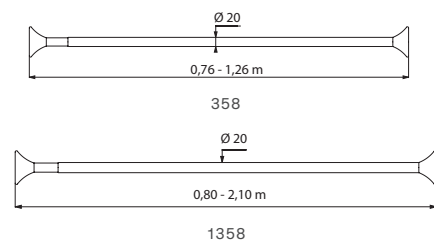

Telescopic, straight curtain rail	
Ø 20mm, from 0.76 to 1.26m	<b>358</b>
Ø 20mm, from 0.80 to 2.10m	<b>1358</b>

### Fixed, angled curtain rail



- Bright polished 304 stainless steel.
- Tube Ø 20mm, 1mm thick.
- Concealed fixings.
- 30-year warranty.

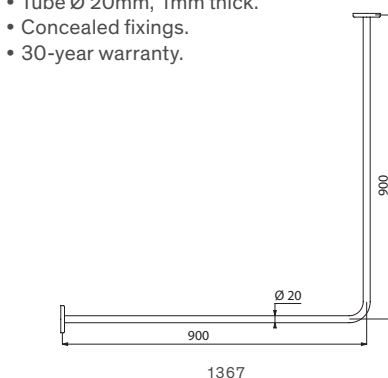

<b>Fixed, angled curtain rail</b>	<b>1367</b>
-----------------------------------	-------------

See our ceiling supports for curtain rails on page 54.

### Adjustable, angled curtain rail



- **Adjusts from 700 – 900mm on either side.**
- Bright polished 304 stainless steel.
- Tube Ø 20mm and 16mm, 1mm thick.
- 30-year warranty.

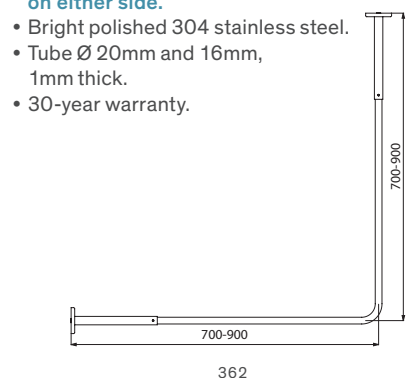

<b>Adjustable, angled curtain rail</b>	<b>362</b>
--	------------

See our ceiling supports for curtain rails on page 54.

**Ceiling support**



- Removable fixing plate.
- Bright polished 304 stainless steel.
- Can be cut to size.
- Tube Ø 20mm, 1mm thick.
- Length 1m.
- 30-year warranty.

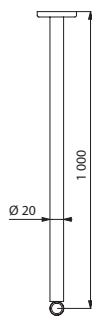

4373

**ECO ceiling support**

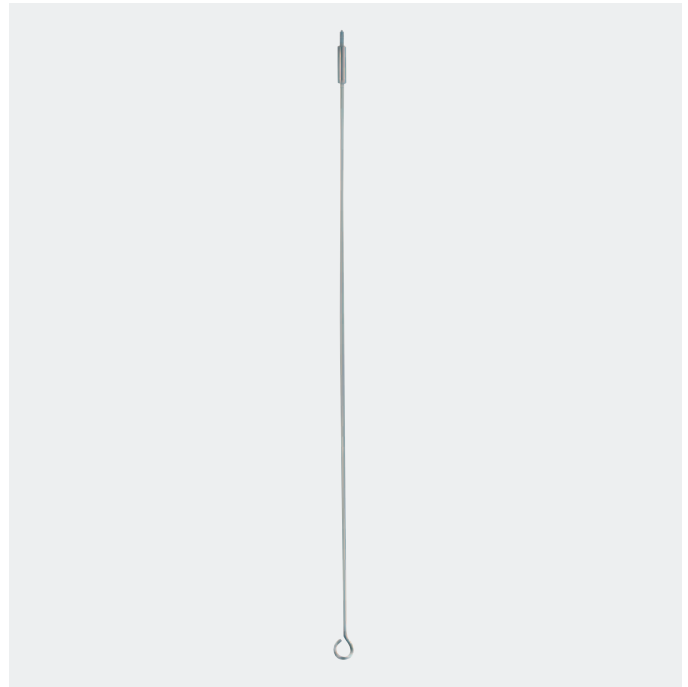

- Bright polished 304 stainless steel and chrome-plated brass.
- Can be cut to size.
- Length 800mm.
- 30-year warranty.



3364/3365

Ceiling support for curtain rails Ø 20mm	4373
--	------

ECO ceiling support	
For curtain rails Ø 16mm	3364
For curtain rails Ø 20mm	3365



### Shower curtain

H. 1,800mm and 2,000mm



- Material: white PVC.
- Supplied with plastic curtain rings.
- 30-year warranty.

Shower curtain - Height 1.8m	
Width 900mm, with 6 curtain rings	<b>381</b>
Width 1,200mm, with 8 curtain rings	<b>382</b>
Width 1,800mm, with 12 curtain rings	<b>387</b>
Shower curtain - Height 2m	
Width 900mm, with 6 curtain rings	<b>1381</b>
Width 1,200mm, with 8 curtain rings	<b>1382</b>
Width 1,800mm, with 12 curtain rings	<b>1386</b>

### Curtain rings for shower curtains

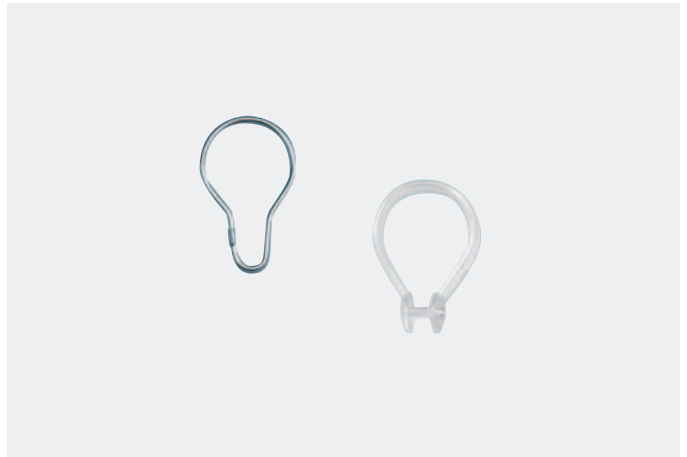

- Supplied in packs of 6.
- 30-year warranty.

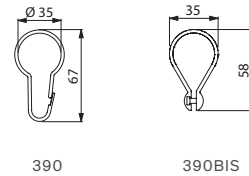

Curtain rings for shower curtains	
Chrome-plated brass, pack of 6	<b>390</b>
Plastic, pack of 6	<b>390BIS</b>

### Duck-board



- **Non-slip.**
- Semi-rigid, white plastic.
- Can be cut to size.
- Dimensions: 22 × 570 × 570mm.
- 30-year warranty.

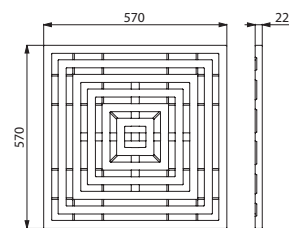

447

Duck-board	<b>447</b>
------------	------------

**ECO robe hook**

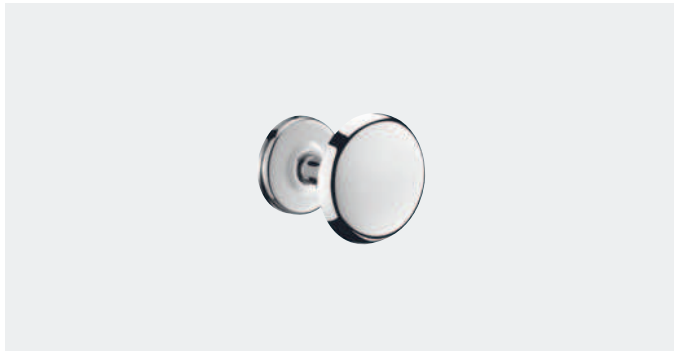

- Bright polished 304 stainless steel.
- Dimensions: Ø 55mm.
- 30-year warranty.

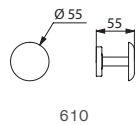

<b>ECO robe hook</b>	<b>610</b>
----------------------	------------

**Wall-mounted shelf and supports**



- Glass shelf with rounded edges, **6mm thick**, 120 × 600mm.
- 120mm chrome-plated shelf supports.
- 30-year warranty.

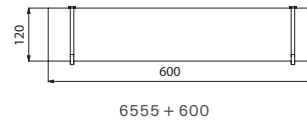

<b>Basin shelf and supports</b>	
Glass shelf	<b>6555</b>
Chrome-plated supports	<b>600</b>

**Toilet brush set**



- Floor-standing and wall-mounted toilet brush set.
- With Nylon brush.
- Dimensions: 145 × 390mm.
- 30-year warranty.

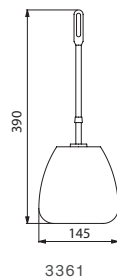

<b>Toilet brush set</b>	
Toilet brush set, with brush	<b>3361</b>
Brush only	<b>3362</b>

**Toilet roll holder**



- Bright polished stainless steel.
- Dimensions: 100 × 134 × 85mm.
- 30-year warranty.

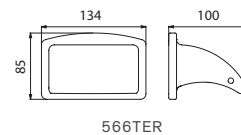

<b>Toilet roll holder</b>	<b>566TER</b>
---------------------------	---------------

### Toilet paper dispenser

Large ABS model



- White ABS.
- For 400m rolls.
- With lock.
- Level control.
- Dimensions: 120 × 310 × 320mm.
- 30-year warranty.

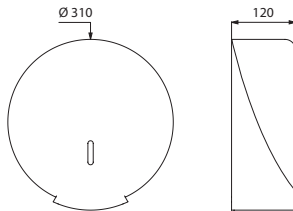

2909

ABS toilet paper dispenser

2909

### Paper towel dispenser

ABS



- White ABS.
- For folded paper towels.
- With lock.
- Level control.
- Capacity: 500 sheets.
- Dimensions: 115 × 275 × 365mm.
- 30-year warranty.

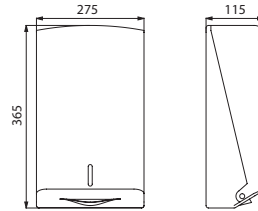

6603D

ABS paper towel dispenser

6603D

Folded paper towels, pack of 180

6606

### Liquid soap dispenser

ABS



- White ABS.
- Push button with non-drip system.
- With lock.
- Level control.
- **Capacity: 0.9 litre.**
- Dimensions: 95 × 130 × 235mm.
- 30-year warranty.

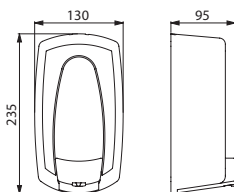

374001

Soap dispenser

374001

### Liquid soap dispenser

Stainless steel



- 304 stainless steel.
- One piece.
- With lock.
- Level control.
- Concealed fixings.
- Top-fill articulated flap.
- **Capacity: 1.2 litres.**
- Dimensions: 70 × 125 × 210mm.
- 30-year warranty.

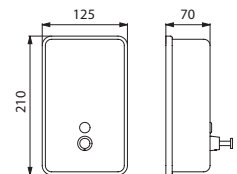

6566/6567

Dispenser, bright polished

6567

Dispenser, polished satin

6566

Valve, spare part

6568

Window, spare part

6569



# Accessibility and Independence Be-Line® Range

SHOWER SEATS  
**63**



GRAB BARS AND DROP-DOWN SUPPORT RAILS  
**69**



SHOWER GRAB BARS  
**74**

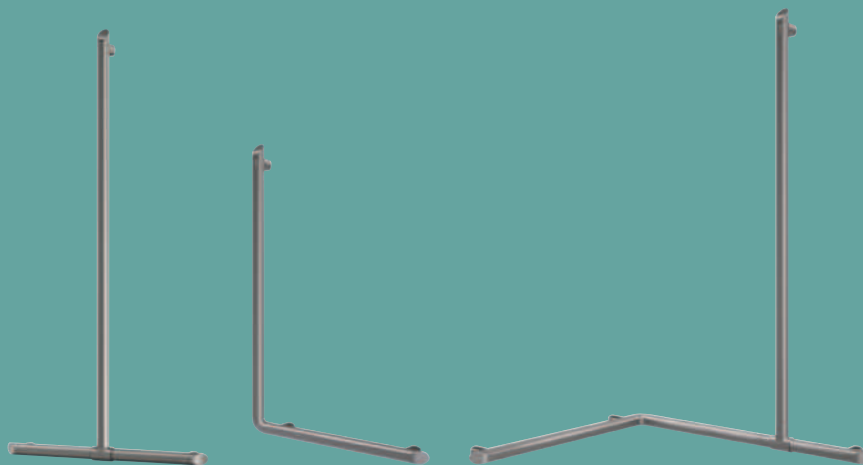

ACCESSORIES  
**78**





## DESIGN, COMFORT, WELL-BEING

### Inclusive design

DELABIE's Be-Line® range combines **aesthetics and comfort**.

The innovative design of the Be-Line® grab bars and shower seats eliminates the medical (and sometimes stigmatising) aspects of accessible washrooms, leaving only a feeling of well-being, free from any complex, both at home and in the wider environment.

The Be-Line® range transcends generations and is suitable for every life stage, regardless of age or level of independence, which makes the shared use of sanitary spaces more agreeable for everyone.

### Discretion and freedom of movement

The Be-Line® range of grab bars and shower seats, with its clean lines, lack of imposing wall plates, concealed fixings and overall quality, naturally integrates into its environment and heightens the impression of comfort as well as providing the necessary level of discretion.

Since they are closer to the wall, the grab bars require less space. This improves access within the sanitary facilities (showers, WCs, etc.) providing greater freedom of movement and an enhanced feeling of comfort.

### Ergonomics

The Be-Line® range of grab bars has a 35mm diameter which provides an **optimum grip** regardless of the product destination or user. The rounded form of these bars, with an **ergonomic, flat front face** that perfectly matches the shape of the hand, **prevents the hand from rotating** and offers greater safety to the user.

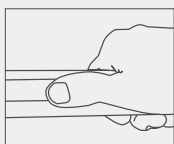

**Ergonomics and safety: prevents rotation** allows placement of thumb and matches the shape of the hand perfectly.

### Three finishes

The Be-Line® range coordinates with all styles and types of materials.

It is available in three aluminium finishes: powder-coated matte white (LRV 82), matte black (LRV 5) and metallised anthracite (LRV 14). This choice of finish provides, most notably, a **good visual contrast** between the colour of the bars or seats and the walls that they are fixed to.

## MAXIMUM HYGIENE

### Durable and resistant material

The Be-Line® range of grab bars and shower seats is made from extruded or injection-moulded aluminium, a durable and resistant material. The smooth, uniform surface is quick and easy to clean, ideal for meeting hygiene requirements.

### Fewer seams

Particular attention has been paid to the design of the Be-Line® range to reduce the number of joins and seams. This reduces the build-up of dirt and niches where bacteria can develop, especially on the straight sections which are extruded in one-piece and which have the most frequent contact with hands.

## MAXIMUM SAFETY

### Tested to over 200kg

In public and commercial places, the user weight is unknown. The products installed must therefore be able to support any user.

### 30-year warranty

The Be-Line® range of grab bars and shower seats is suitable for intensive use in all types of public or healthcare buildings.

### CE marked

DELABIE's Be-Line® range is CE marked and conforms to European Directive 93/42/CEE that relates to medical devices, and complies with European standard EN ISO 21856 "Technical aids". This provides an additional guarantee for product users.

### 38mm safety gap

The elderly or people with reduced mobility can easily lose their balance and fall. Limiting the gap between the Be-line® range of grab bars and the wall to just 38mm prevents the forearm from getting trapped and significantly reduces the risk of fracture.

### Robust metal thickness

The thickness of the aluminium used by DELABIE to make the Be-Line® range is significant: 3mm for the tube sections and solid aluminium for the injection-moulded fixing elements. It is an essential feature that attests to the high quality and strength of these products.

## AND ALSO...

### 100% interchangeable

Be-line® grab bars dimensions are checked during the manufacturing process. There is no need to drill additional holes in the wall if replacing the bar with an identical one.

### 100% recyclable

Aluminium is 100% recyclable, contributing to sustainable development and protecting the environment.

### Complete range

Offering a wide range of products enables DELABIE to respond to the needs and requirements of the accessibility and independence sector. This offering complements DELABIE's other product ranges perfectly.

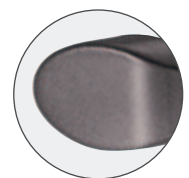

Metallised anthracite



Matte white



Matte black

**ALUMINIUM**  
Resistant and durable material

**INNOVATIVE DESIGN**  
Suitable for all users  
Feeling of well-being

**SEAM-FREE**  
No bacterial niches

**3 FINISHES**  
Coordinates with all styles  
Visual contrast



**100% RECYCLABLE**

**ERGONOMIC FLAT SURFACE**  
Optimal grip  
Safety: prevents hand rotating

**TESTED TO OVER 200KG**  
**30-YEAR WARRANTY**  
**CE MARKED**

**38MM SAFETY GAP**  
Reduced risk of fracture  
Space saving

**SOLID ALUMINIUM**  
Safety

**SLIDING 'T'**  
Adapts to all installations  
left or right side

**3MM THICK**  
High resistance





## Removable lift-up shower seat

Without leg



- **Large model.**
- **Removable:** easy to remove with **anti-theft locking** system. Reduces the number of shower seats in a facility, allowing installation only when required e.g. hotels or hospitals providing short-term accommodation for people with reduced mobility.
- **Retained in upright position.**
- **Slowed down descent.**
- Suitable for intensive use in public places or the healthcare sector.
- **Solid, reinforced seat** made from high-strength polymer which can be installed, without a supporting leg, on any suitable wall.
- **Non-slip surface.**
- Choice of powder-coated metallised anthracite (LRV 14), matte white (LRV 82) or matte black (LRV 5) finish; provides a good visual contrast with the wall.
- **Solid aluminium** mounting bracket.
- Good resistance to disinfectant (Povidone-iodine).
- 5 concealed fixing points.
- Supplied with stainless steel screws  $\varnothing 8 \times 70\text{mm}$  for concrete walls.
- Dimensions:  $455 \times 450 \times 90\text{mm}$ .
- Folded dimensions:  $85 \times 470\text{mm}$ .
- Tested to over 200kg. Maximum recommended user weight: 135kg.
- 30-year warranty.
- CE marked.

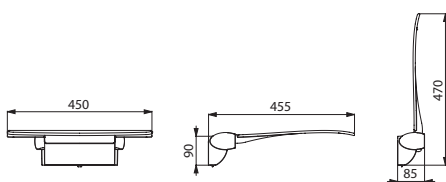

511920

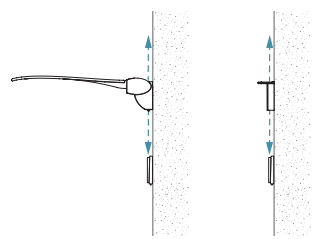

When the seat is not in use it can be replaced by shelf ref. 511921W

### Removable lift-up shower seat

Metallised anthracite powder-coated aluminium	<b>511920C</b>
Matte white powder-coated aluminium	<b>511920W</b>
Matte black powder-coated aluminium	<b>511920BK</b>

## Related products

### Backrest for shower seats



- Solid backrest made from high-resistant polymer.
- Non-slip surface.
- 4 concealed fixing points.
- Supplied with  $\varnothing 5 \times 60\text{mm}$  screws and two  $\varnothing 5 \times 50\text{mm}$  screws.
- Dimensions:  $450 \times 415 \times 40\text{mm}$ .
- 30-year warranty.

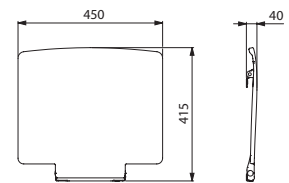

511929

### Backrest for shower seats

**511929**

### Wall-mounted shower shelf to conceal bracket

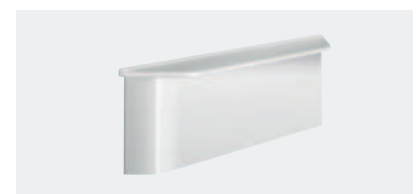

- Conceals the mounting bracket when the lift-up shower seat is removed.
- Reduces the number of lift-up shower seats in a facility, allowing installation only when required.
- Dimensions:  $55 \times 275 \times 90\text{mm}$ .
- 30-year warranty.

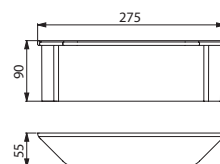

511921

### Wall-mounted shower shelf to conceal bracket

Matte white	<b>511921W</b>
Matte white with mounting bracket	<b>511921FW</b>



Be-Line® lift-up shower seat **511930C** - Be-Line® T-shaped shower grab bar **511944C** - Be-Line® sliding shower head holder **511911C** - Be-Line® soap dish **511912W**  
Recessed SECURITHERM sequential thermostatic shower mixer **H96CBOX+H9633**

## Removable lift-up shower seat

With leg



- **Large model.**
- **Removable:** easy to remove with **anti-theft locking** system. Reduces the number of shower seats in a facility, allowing installation only when required e.g. hotels or hospitals providing short-term accommodation for people with reduced mobility.
- **Retained in upright position. Slowed down descent.**
- Suitable for intensive use in public places or the healthcare sector.
- Solid seat made from high-strength polymer.
- **Non-slip surface.**
- **Reinforced** by a central, hinged **leg** which retracts automatically.
- Choice of metallised anthracite (LRV 14), matte white (LRV 82) or matte black (LRV 5) finish; provides a good visual contrast with the wall.
- Good resistance to disinfectant (Povidone-iodine).
- 5 concealed fixing points.
- Supplied with stainless steel screws  $\varnothing 8 \times 70\text{mm}$  for concrete walls.
- Dimensions:  $443 \times 450 \times 480\text{mm}$ . Folded dimensions:  $87 \times 541\text{mm}$ .
- Tested to over 200kg. Maximum recommended user weight: 135kg.
- 30-year warranty.
- CE marked.

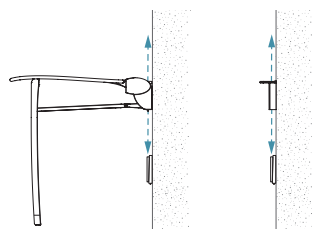
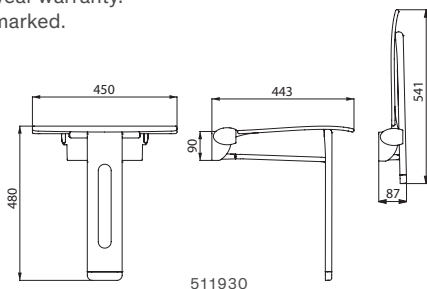

When the seat is not in use it can be replaced by shelf ref. 511921W

### Removable lift-up shower seat with leg

Metallised anthracite	<b>511930C</b>
Matte white	<b>511930W</b>
Matte black	<b>511930BK</b>

## Related products

### Backrest for shower seats



- Solid backrest made from high-resistant polymer.
- Non-slip surface.
- 4 concealed fixing points.
- Supplied with  $\varnothing 5 \times 60\text{mm}$  screws and two  $\varnothing 5 \times 50\text{mm}$  screws.
- Dimensions:  $450 \times 415 \times 40\text{mm}$ .
- 30-year warranty.

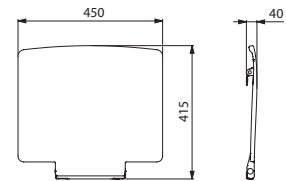

511929

Backrest for shower seats	<b>511929</b>
---------------------------	---------------

### Wall-mounted shower shelf to conceal bracket

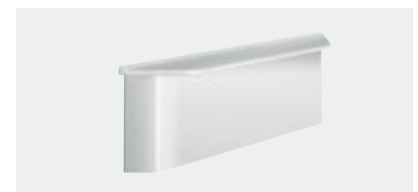

- Conceals the mounting bracket when the lift-up shower seat is removed.
- Reduces the number of lift-up shower seats in a facility, allowing installation only when required.
- Dimensions:  $55 \times 275 \times 90\text{mm}$ .
- 30-year warranty.

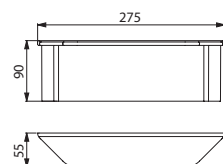

511921

### Wall-mounted shower shelf to conceal bracket

Matte white	<b>511921W</b>
Matte white with mounting bracket	<b>511921FW</b>



Be-Line® shower stool **511418BK** - Be-Line® T-shaped shower grab bar **511944BK** - Be-Line® shower head holder **511911BK**  
BIOSAFE thermostatic shower mixer **H9768** - Mechanical basin mixer with pressure-balancing **2721TEP**

Shower stool



Stool in anthracite



White stool



Black stool

- **Wide model with ergonomic handles.**
- Suitable for intensive use in public places and hospitals.
- Choice of matte white, matte black or anthracite seat finishes for a good visual contrast with the wall.
- Solid seat made from high strength polymer.
- **Non-slip surface.**
- 4 polished 304 stainless steel feet Ø 18 × 2mm.
- Plastic protective caps on feet to match seat finish.
- Good resistance to disinfectant (Povidone-iodine).
- Dimensions: 360 × 540 × 480mm.
- Tested to over 200kg. Maximum recommended user weight: 135kg.
- 30-year warranty.

Shower stool	
Stool in anthracite	511418C
White stool	511418W
Black stool	511418BK

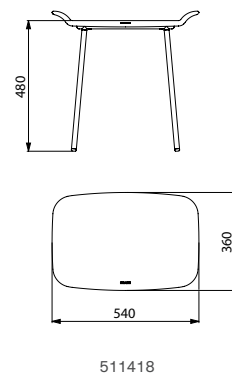

ACCESSIBILITY  
BE-LINE®



Be-Line® drop-down support rail **511960BK** - Angled grab bar 135° **511982BK** - 700 S wall-hung WC pan **110710BK** - TEMPOMATIC dual control WC recessed electronic flush system in matte black **464SBOX+464050** - Wall-mounted toilet brush set with lid **4051BK** - Toilet roll holder **511966BK** - Coat hooks **511943BK**

## Angled grab bar 135°

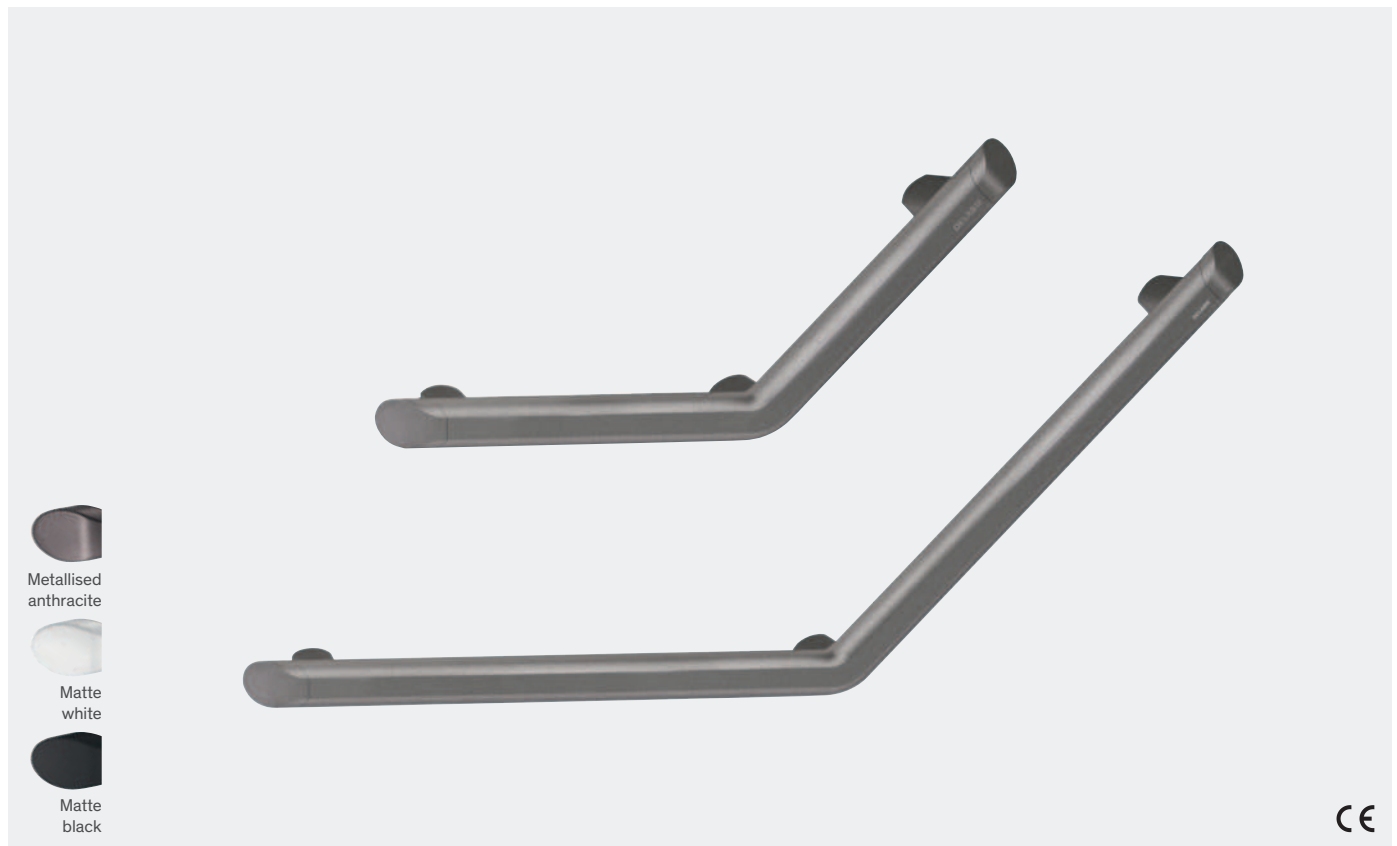

ACCESSIBILITY  
BE-LINE®

- For WCs, showers or baths.
- For use as a handrail (horizontal part) or as a grab bar (135° part).
- Universal for either left or right side.
- Aluminium tube thickness 3mm. Solid aluminium fixing points.
- Rounded profile Ø 35mm with ergonomic flat front face that prevents rotation for an optimal grip.
- Choice of powder-coated metallised anthracite (LRV 14), matte white (LRV 82) or matte black (LRV 5) finish; provides a good visual contrast with the wall.
- Uniform surface for easy maintenance and hygiene.
- 38mm gap between the bar and the wall: minimal space prevents the forearm passing between the bar and the wall, reducing the risk of fracture in case of loss of balance.
- 3 fixing points prevent the hand from getting trapped and simplify installation.
- Concealed fixings.
- Supplied with stainless steel screws Ø 8 × 70mm for concrete walls.
- Dimensions: 400 × 400mm or 220 × 220mm.
- Tested to over 200kg. Maximum recommended user weight: 135kg.
- 30-year warranty.
- CE marked.

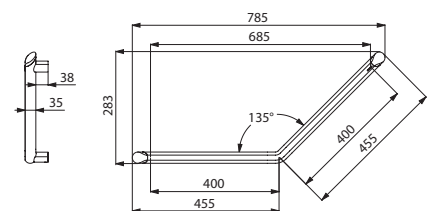

511982

Angled grab bar 135° - 400 × 400mm	
Metallised anthracite powder-coated aluminium	<b>511982C</b>
Matte white powder-coated aluminium	<b>511982W</b>
Matte black powder-coated aluminium	<b>511982BK</b>
Angled grab bar 135° - 220 × 220mm	
Metallised anthracite powder-coated aluminium	<b>511983C</b>
Matte white powder-coated aluminium	<b>511983W</b>
Matte black powder-coated aluminium	<b>511983BK</b>

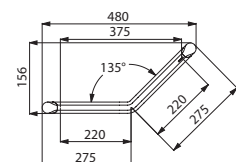

511983





## Straight grab bar

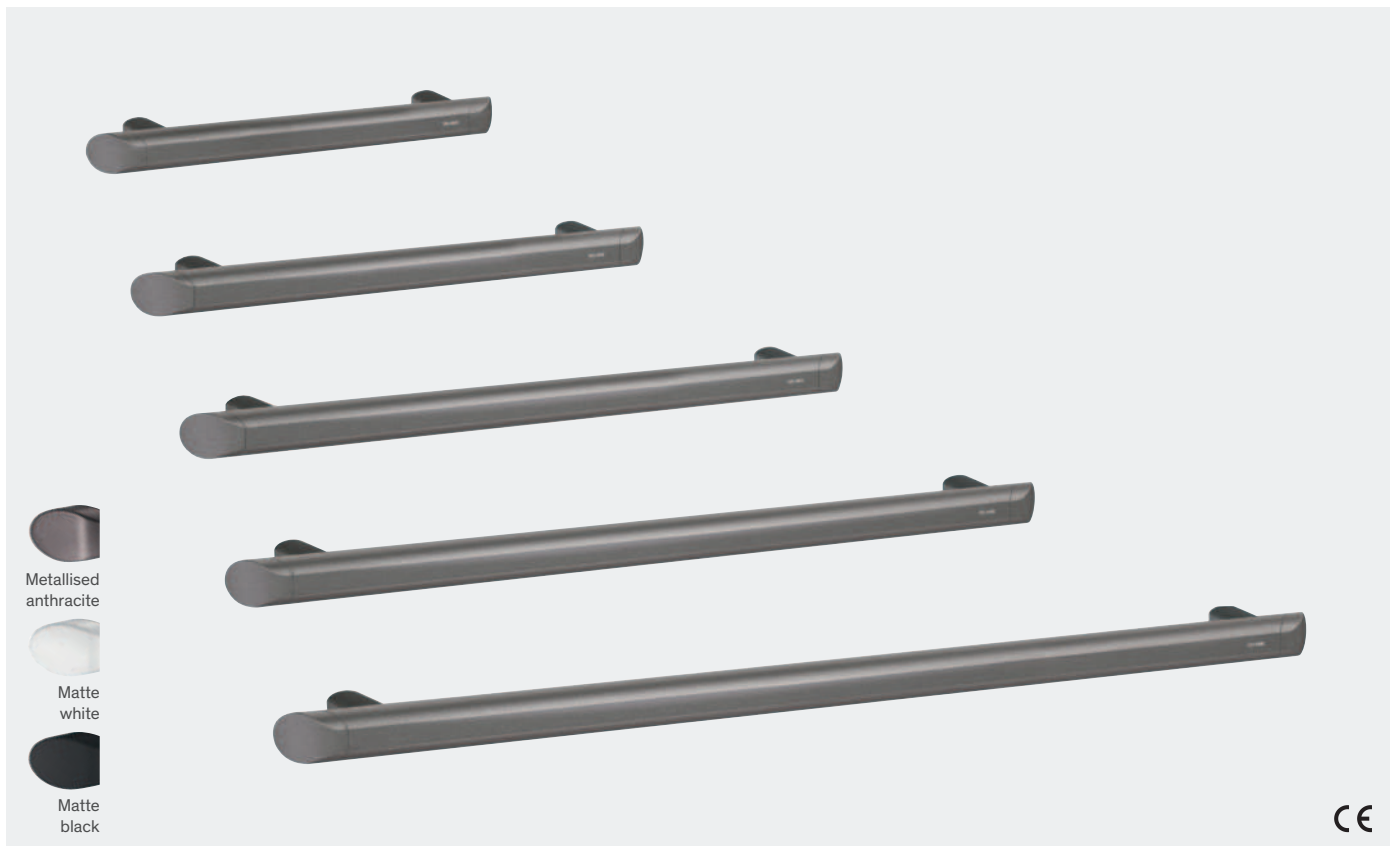

- For WCs, showers or baths.
- For use as a handrail and grab bar or support rail.
- Aluminium tube thickness 3mm. Solid aluminium fixing points.
- Rounded profile Ø 35mm with ergonomic flat front face that prevents rotation for an optimal grip.
- Choice of powder-coated metallised anthracite (LRV 14), matte white (LRV 82) or matte black (LRV 5) finish; provides a good visual contrast with the wall.
- Uniform surface for easy maintenance and hygiene.
- 38mm gap between the bar and the wall: minimal space prevents the forearm passing between the bar and the wall, reducing the risk of fracture in case of loss of balance.
- Concealed fixings.
- Supplied with stainless steel screws Ø 8 × 70mm for concrete walls.
- Dimensions: 300 - 900mm centre-to-centre.
- Tested to over 200kg. Maximum recommended user weight: 135kg.
- 30-year warranty. CE marked.

Straight grab bar - Metallised anthracite	
Metallised anthracite powder-coated aluminium - 300mm	<b>511903C</b>
Metallised anthracite powder-coated aluminium - 400mm	<b>511904C</b>
Metallised anthracite powder-coated aluminium - 500mm	<b>511905C</b>
Metallised anthracite powder-coated aluminium - 600mm	<b>511906C</b>
Metallised anthracite powder-coated aluminium - 900mm	<b>511909C</b>
Straight grab bar - Matte white	
Matte white powder-coated aluminium - 300mm	<b>511903W</b>
Matte white powder-coated aluminium - 400mm	<b>511904W</b>
Matte white powder-coated aluminium - 500mm	<b>511905W</b>
Matte white powder-coated aluminium - 600mm	<b>511906W</b>
Matte white powder-coated aluminium - 900mm	<b>511909W</b>
Straight grab bar - Matte black	
Matte black powder-coated aluminium - 300mm	<b>511903BK</b>
Matte black powder-coated aluminium - 400mm	<b>511904BK</b>
Matte black powder-coated aluminium - 500mm	<b>511905BK</b>
Matte black powder-coated aluminium - 600mm	<b>511906BK</b>
Matte black powder-coated aluminium - 900mm	<b>511909BK</b>

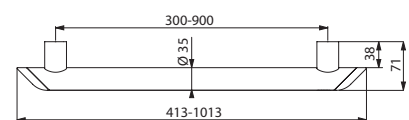

511903/511904/511905/511906/511909



Be-Line® drop-down support rail with leg **511962W** - Be-Line® angled grab bar 135° **511982W**  
TEMPOMATIC dual control recessed electronic direct flush WC valve **464PBOX+464006**

## Drop-down support rail



- For WCs or showers.
- Allows side access in the raised position.
- In the lowered position use as a grab bar, as a support for standing and for assisting movement.
- **Removable:** easy to remove with **anti-theft locking** system. Reduces the number of bars in a facility, allowing installation only when required e.g. hotels or hospitals providing short-term accommodation for people with reduced mobility.
- **Slowed down descent. Retained in upright position.**
- Aluminium tube.
- Rounded profile  $\varnothing 42$ mm with ergonomic flat front face that prevents rotation for an optimal grip.
- Choice of powder-coated metallised anthracite (LRV 14), matte white (LRV 82) or matte black (LRV 5) finish; provides a good visual contrast with the wall.
- Uniform surface for easy maintenance and hygiene.
- Concealed fixings secured to wall by a 304 stainless steel plate, 5mm thick.
- Supplied with stainless steel screws  $\varnothing 8 \times 70$ mm for concrete walls.
- Models with leg: **to be used as reinforcement when the wall fixing alone is insufficient.** Dimensions: 850 or 650  $\times$  825  $\times$  120mm. Leg height can be adjusted from 760 - 780mm.
- Models without leg: 850 or 650  $\times$  202  $\times$  120mm.
- Tested to over 200kg.
- Maximum recommended user weight: 135kg.
- 30-year warranty.
- CE marked.

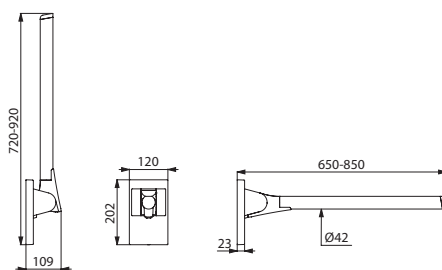

511960/511964

Drop-down support rail without leg	
Metallised anthracite powder-coated aluminium - L. 650mm	511960C
Metallised anthracite powder-coated aluminium - L. 850mm	511964C
Matte white powder-coated aluminium - L. 650mm	511960W
Matte white powder-coated aluminium - L. 850mm	511964W
Matte black powder-coated aluminium - L. 650mm	511960BK
Matte black powder-coated aluminium - L. 850mm	511964BK
Drop-down support rail with leg	
Metallised anthracite powder-coated aluminium - L. 650mm	511962C
Metallised anthracite powder-coated aluminium - L. 850mm	511963C
Matte white powder-coated aluminium - L. 650mm	511962W
Matte white powder-coated aluminium - L. 850mm	511963W
Matte black powder-coated aluminium - L. 650mm	511962BK
Matte black powder-coated aluminium - L. 850mm	511963BK

## Additional products



WC backrest and toilet roll holder (see page 79)



## Related product

### Cover plate



- Conceals fixing screws when the drop-down support rail is removed.
- Reduces the number of drop-down support rails in a facility, allowing installation only when required. Example: hotels or hospitals providing short-term accommodation for people with reduced mobility.
- Model with fixing plate: supplied with stainless steel screws for concrete walls.
- 30-year warranty.

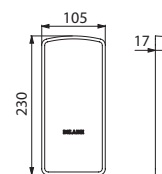

511950

Cover without fixing plate	
Metallised anthracite	511950C
Matte white	511950W
Cover with fixing plate	
Metallised anthracite	511950FC
Matte white	511950FW

T-shaped grab bar with sliding vertical riser rail



Additional products



Sliding shower head holder, sliding soap dish and shower shelf with glove holder (see page 78)

- For showers.
- Use as a grab bar and to support the user in an upright position.
- Helps and secures entry and movement in the shower.
- Use as a shower riser rail by adding a sliding shower head holder and/or a soap dish.
- Upright position can be adjusted during installation: can be moved to the left or the right in order to adapt the space (positioning of shower, depth of shower seat...).
- Aluminium tube thickness 3mm. Solid aluminium fixing points.
- Rounded profile Ø 35mm with ergonomic flat front face that prevents rotation for an optimal grip.
- Choice of powder-coated metallised anthracite (LRV 14), matte white (LRV 82) or matte black (LRV 5) finish; provides a good visual contrast with the wall.
- Uniform surface for easy maintenance and hygiene.
- 38mm gap between the bar and the wall: minimal space prevents the forearm passing between the bar and the wall, reducing the risk of fracture in case of loss of balance.
- Concealed fixings.
- Supplied with stainless steel screws Ø 8 × 70mm for concrete walls.
- Dimensions: 1,130 × 500mm.
- Tested to over 200kg. Maximum recommended user weight: 135kg.
- 30-year warranty.
- CE marked.

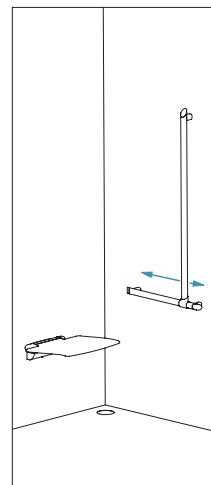

Upright can be moved

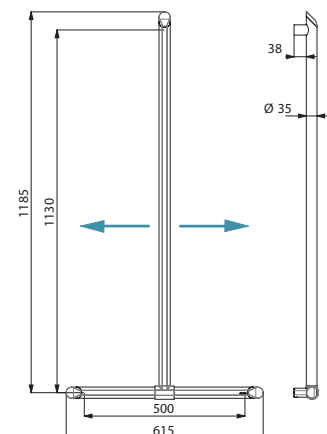

511944

T-shaped grab bar with sliding vertical riser rail	
Metallised anthracite powder-coated aluminium	511944C
Matte white powder-coated aluminium	511944W
Matte black powder-coated aluminium	511944BK

## L-shaped grab bar



- For showers or baths.
- Helps the user stand and move safely in the shower or bath.
- Use as a shower rail by adding a sliding shower head holder and/or a soap dish.
- Can be installed with the upright to the left or the right.
- Aluminium tube thickness 3mm. Solid aluminium fixing points.
- Rounded profile Ø 35mm with ergonomic flat front face that prevents rotation for an optimal grip.
- Choice of powder-coated metallised anthracite (LRV 14), matte white (LRV 82) or matte black (LVR 5) finish; provides a good visual contrast with the wall.
- Uniform surface for easy maintenance and hygiene.
- 38mm gap between the bar and the wall: minimal space prevents the forearm passing between the bar and the wall, reducing the risk of fracture in case of loss of balance.
- Concealed fixings.
- Supplied with stainless steel screws Ø 8 × 70mm for concrete walls.
- Dimensions: 1,130 or 750 × 450mm.
- Tested to over 200kg. Maximum recommended user weight: 135kg.
- 30-year warranty.
- CE marked.

L-shaped grab bar - Metallised anthracite	
Metallised anthracite powder-coated aluminium - H. 750mm	511970C
Metallised anthracite powder-coated aluminium - H. 1,130mm	511971C
L-shaped grab bar - Matte white	
Matte white powder-coated aluminium - H. 750mm	511970W
Matte white powder-coated aluminium - H. 1,130mm	511971W
L-shaped grab bar - Matte black	
Matte black powder-coated aluminium - H. 750mm	511970BK
Matte black powder-coated aluminium - H. 1,130mm	511971BK

## Additional products

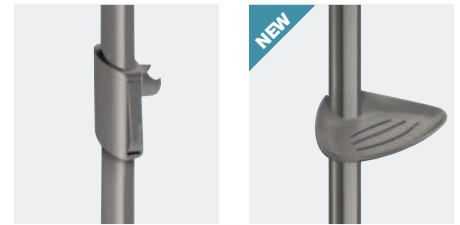

Sliding shower head holder, sliding soap dish and shower shelf with glove holder (see page 78)

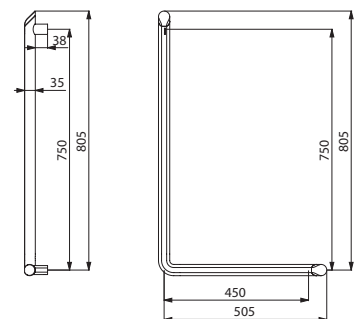

511970

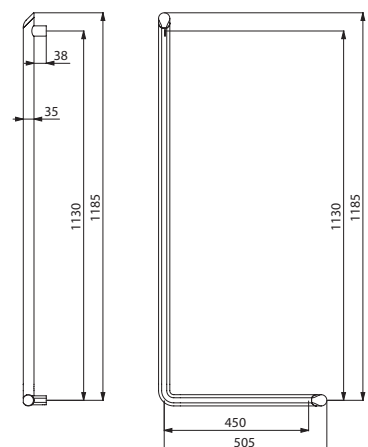

511971

Two-wall corner grab bar



- For WCs, showers or baths.
- Use as a grab bar and to support the user in an upright position.
- Helps and secures entry and movement in the shower also with getting in and out of the bath.
- Helps with the transfer from a wheelchair to the toilet seat, for WCs with recessed cisterns or direct flush.
- Aluminium tube thickness 3mm. Solid aluminium fixing points.
- Rounded profile Ø 35mm with ergonomic flat front face that prevents rotation for an optimal grip.
- Choice of powder-coated metallised anthracite (LRV 14), matte white (LRV 82) or matte black (LRV 5) finish; provides a good visual contrast with the wall.
- Uniform surface for easy maintenance and hygiene.
- 38mm gap between the bar and the wall: minimal space prevents the forearm passing between the bar and the wall, reducing the risk of fracture in case of loss of balance.
- Concealed fixings.
- Supplied with stainless steel screws Ø 8 × 70mm for concrete walls.
- Dimensions: 695 × 695mm.
- Tested to over 200kg. Maximum recommended user weight: 135kg.
- 30-year warranty.
- CE marked.

Additional product

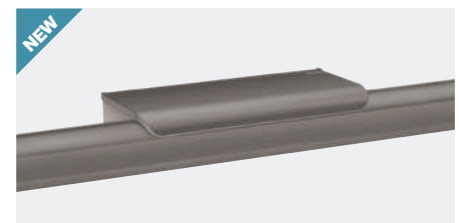

Shower shelf with glove holder (see page 78)

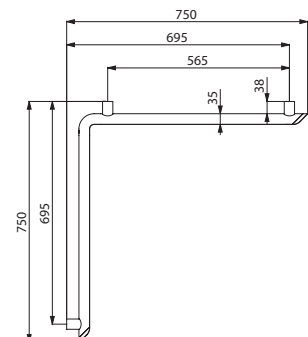

Two-wall corner grab bar	
Metallised anthracite powder-coated aluminium	511941C
Matte white powder-coated aluminium	511941W
Matte black powder-coated aluminium	511941BK

511941

## Two-wall grab bar with sliding vertical riser rail



### Additional products



Sliding shower head holder, sliding soap dish and shower shelf with glove holder (see page 78)

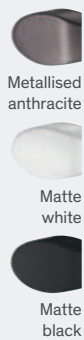

- For showers.
- Use as a grab bar and to support the user in an upright position.
- Helps and secures entry and movement in the shower.
- Use as a shower riser rail by adding a sliding shower head holder and/or a soap dish.
- Upright position can be adjusted during installation: can be moved to the left or the right in order to adapt the space (positioning of shower, depth of shower seat...).
- Can be installed with the upright on the left or the right.
- Aluminium tube thickness 3mm. Solid aluminium fixing points.
- Rounded profile Ø 35mm with ergonomic flat front face that prevents rotation for an optimal grip.
- Choice of powder-coated metallised anthracite (LRV 14), matte white (LRV 82) or matte black (LRV 5) finish; provides a good visual contrast with the wall.
- Uniform surface for easy maintenance and hygiene.
- 38mm gap between the bar and the wall: minimal space prevents the forearm passing between the bar and the wall, reducing the risk of fracture in case of loss of balance.
- Concealed fixings.
- Supplied with stainless steel screws Ø 8 × 70mm for concrete walls.
- Dimensions: 1,130 × 695 × 695mm.
- Tested to over 200kg. Maximum recommended user weight: 135kg.
- 30-year warranty. CE marked.

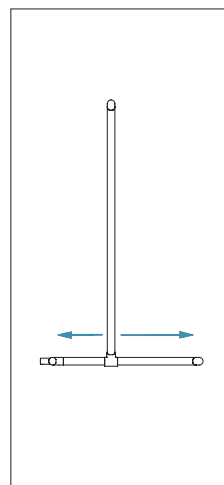

Upright can be moved to the left or the right

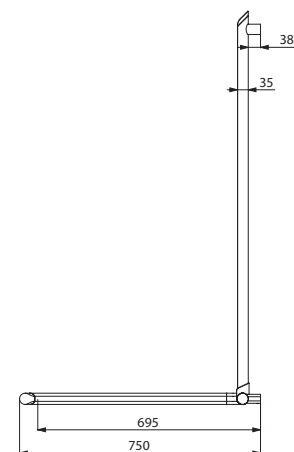

511949

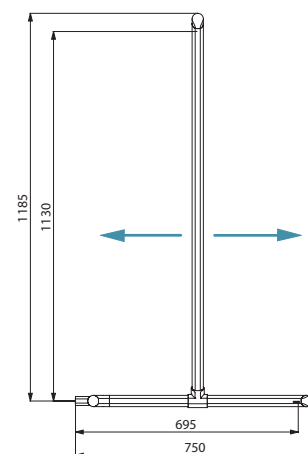

511949

#### Two-wall grab bar with sliding vertical riser rail

Metallised anthracite powder-coated aluminium	511949C
Matte white powder-coated aluminium	511949W
Matte black powder-coated aluminium	511949BK

### Sliding shower head holder



- Holder for tilting shower heads.
- Easy-to-operate ergonomic grip to adjust the height of the shower head holder.
- Slides by using the handle or by pulling on shower hose.
- For Be-Line® shower rails.
- 30-year warranty.

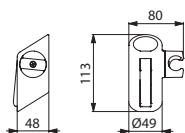

511911

Provisional availability for matte black model: 2<sup>nd</sup> half 2024. Please contact sales office to check availability.

Sliding shower head holder	
Metallised anthracite	<b>511911C</b>
Matte white	<b>511911W</b>
Matte black	<b>511911BK</b>

### Sliding soap dish



- Soap dish for shower gel or soap.
- For Be-Line® shower rails.
- 30-year warranty.

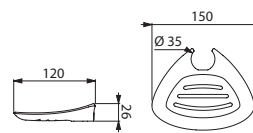

511912

Provisional availability for matte black model: 1<sup>st</sup> half 2024. Please contact sales office to check availability.

Sliding soap dish	
Metallised anthracite	<b>511912C</b>
Matte white	<b>511912W</b>
Matte black	<b>511912BK</b>

### Shower head retaining collar



- For Ø 25 - 35mm rails and flexible shower hoses.
- **Retaining device:** prevents shower head from coming into direct contact with the floor or floor trap (source of bacterial contamination).
- 30-year warranty.

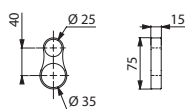

830

Translucent shower head retaining collar	<b>830</b>
--	------------

### Shower shelf for grab bars

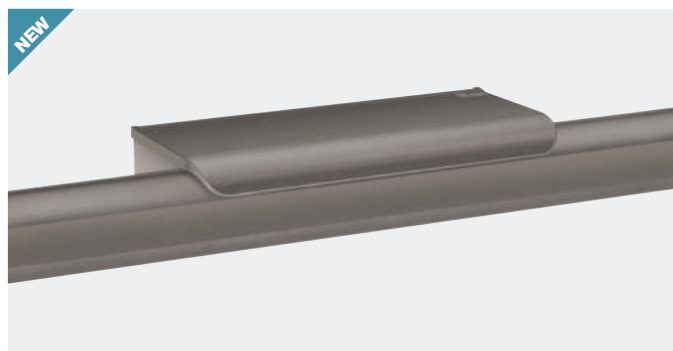

- Place against the wall, on the grab bar.
- **Anti-theft lock.**
- Suitable for shower gels or soap.
- **2 hooks for gloves.**
- 30-year warranty.

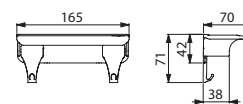

511922

Provisional availability for matte black model: 1<sup>st</sup> half 2024. Please contact sales office to check availability.

Shower shelf for grab bars	
Metallised anthracite	<b>511922C</b>
Matte white	<b>511922W</b>
Matte black	<b>511922BK</b>



### Toilet roll holder for drop-down support rails



- For toilet rolls.
- For Be-Line® drop-down support rails.
- Can be installed without removing the rail.
- 30-year warranty.

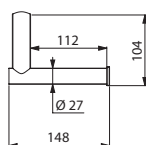

511965

Toilet roll holder for drop-down support rails	
Metallised anthracite	<b>511965C</b>
Matte white	<b>511965W</b>

### Wall-mounted toilet roll holder



- For toilet rolls.
- Choice of powder-coated metallised anthracite (LRV 14), matte white (LRV 82) or matte black (LRV 5) finish; provides a good visual contrast with the wall.
- Concealed fixings.
- 30-year warranty.

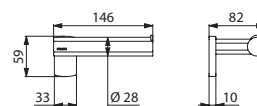

511966

Wall-mounted toilet roll holder	
Metallised anthracite powder-coated aluminium	<b>511966C</b>
Matte white powder-coated aluminium	<b>511966W</b>
Matte black powder-coated aluminium	<b>511966BK</b>

### Comfort backrest for WCs



- Flexible backrest made from polyurethane.
- Aluminium structure.
- Dimensions: 150 × 513 × 173mm.
- 30-year warranty.
- CE marked.

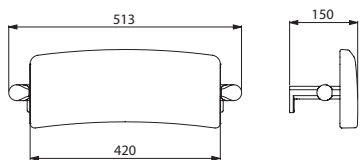

511928

Comfort backrest for WCs	
Metallised anthracite powder-coated aluminium structure	<b>511928C</b>
Matte white powder-coated aluminium structure	<b>511928W</b>
Matte black powder-coated aluminium structure	<b>511928BK</b>

### Coat hook



- Concealed fixings.
- Choice of powder-coated metallised anthracite (LRV 14), matte white (LRV 82) or matte black (LRV 5) finish; provides a good visual contrast with the wall.
- 30-year warranty.

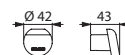

511943

Coat hook	
Metallised anthracite powder-coated aluminium	<b>511943C</b>
Matte white powder-coated aluminium	<b>511943W</b>
Matte black powder-coated aluminium	<b>511943BK</b>

**Toilet brush set without lid**

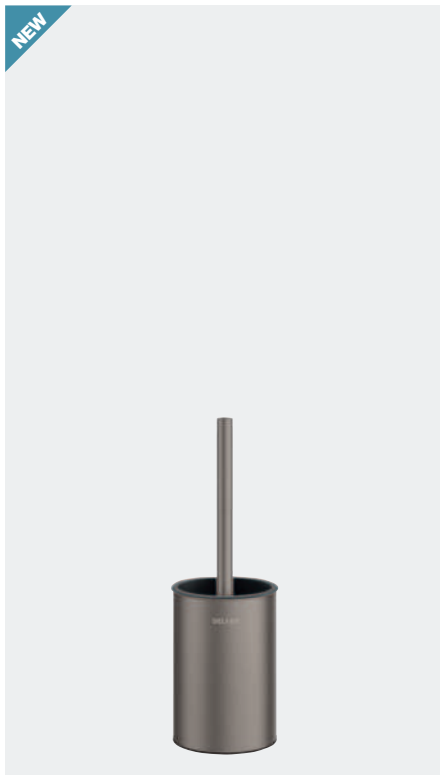

- **Robust model.**
- Bacteriostatic 304 stainless steel.
- Wall-mounted model.
- Easy to clean: plastic bowl can be removed from above.
- **Plastic bowl with reservoir:** prevents toilet brush sitting in residual water and reduces the risk of splashing when next used.
- **Anti-theft lock.**
- Choice of powder-coated metallised anthracite (LRV 14) or matte white (LRV 82) finish; provides a good visual contrast with the wall.
- Stainless steel thickness: 1mm body.
- Dimensions: Ø 90 × 330mm.
- 30-year warranty.

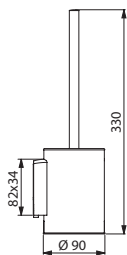

4048

Toilet brush set without lid - Anti-theft lock	
Metallised anthracite powder-coated 304 stainless steel	<b>4048C</b>
Matte white powder-coated 304 stainless steel	<b>4048MW</b>

**Toilet brush set with lid**



- **Robust model.**
- Bacteriostatic 304 stainless steel.
- Wall-mounted model.
- **Ergonomic handle extension possible:** easy for wheelchair users or people who have difficulty bending to use.
- Easy to clean: plastic bowl can be removed from above.
- **Plastic bowl with reservoir:** prevents toilet brush sitting in residual water and reduces the risk of splashing when next used.
- Toilet brush **automatically centres itself** in the holder.
- **Anti-theft lock.**
- Choice of powder-coated metallised anthracite (LRV 14) or matte white (LRV 82) finish: provides a good visual contrast with the wall.
- Stainless steel thickness: 1mm body.
- Dimensions: Ø 90 × 410mm.
- 30-year warranty.

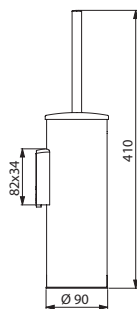

4051

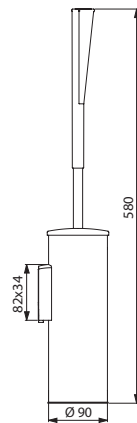

4051+4051M

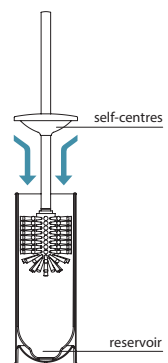

Toilet brush set with lid - Anti-theft lock	
Metallised anthracite powder-coated 304 stainless steel	<b>4051C</b>
Matte white powder-coated 304 stainless steel	<b>4051MW</b>
<b>Ergonomic extension for toilet brush handle</b>	<b>4051M</b>

### Tilting mirror with long, ergonomic lever



- **For combined installation:** can be used from sitting or standing position.
- **Long, ergonomic lever for easy adjustment of mirror angle from a sitting position or from a wheelchair.**
- Lever with anti-bacterial treatment: optimal protection against bacterial development.
- **Quick and easy to install:** simply clip into place.
- **Anti-theft lock.**
- Bright white HR Nylon lever.
- Mirror made from 6mm laminated safety glass.
- Can be tilted up to 20°.
- Mirror dimensions: 500 × 600mm.
- 30-year warranty.

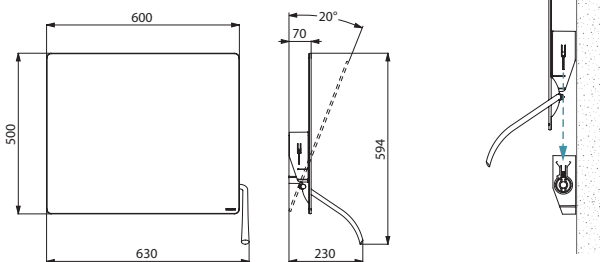

510201N

**Tilting mirror with long, ergonomic lever** **510201N**

For more mirrors and studded pegs see pages 43-45.

### Tilting mirror with tab handle



- **For combined installation:** can be used from sitting or standing position.
- **Tab handle for easy adjustment of mirror angle for those in a sitting position or for wheelchair users.**
- Handle with anti-bacterial treatment: optimal protection against bacterial development.
- **Quick and easy to install:** simply clip into place.
- **Anti-theft lock.**
- Mirror made from 6mm laminated safety glass.
- Can be tilted up to 20°.
- Mirror dimensions: 500 × 600mm.
- 30-year warranty.

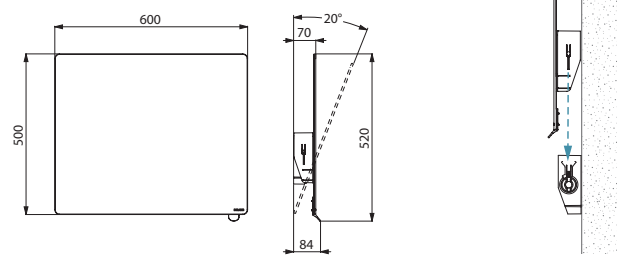

510202

**Tilting mirror with tab handle**

Metallised anthracite tab handle	<b>510202C</b>
White Nylon tab handle	<b>510202N</b>
Black tab handle	<b>510202BK</b>

For more mirrors and studded pegs see pages 43-45.

ACCESSIBILITY  
BE-LINE®



# Accessibility and Independence Stainless Steel Range

SHOWER  
SEATS  
**87**



GRAB BARS  
& DROP-DOWN  
SUPPORT RAILS  
**91**



SHOWER  
GRAB BARS  
**96**



ACCESSORIES  
**104**

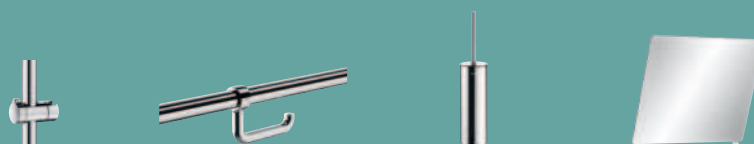

STAINLESS STEEL  
SANITARY WARE  
**110**





### MAXIMUM SAFETY

#### Tested to over 200kg

In public and commercial places, the user weight is unknown. The products installed must therefore be able to support any user.

#### 30-year warranty

DELABIE's grab bars and shower seats are suitable for intensive use in all types of public or healthcare buildings. Stainless steel is a noble metal alloy (chrome, nickel and steel) which has no surface treatments, so if it gets scratched or cut there is **no risk of rust appearing**. DELABIE's stainless steel products remain in perfect condition throughout their lifespan.

#### CE marked

DELABIE's grab bars and shower seats are CE marked and conform to European Directive 93/42/CEE that relates to medical devices, and complies with European standard EN ISO 21856 "Technical aids". This provides an additional guarantee for product users.

#### 40mm safety gap

The elderly or people with reduced mobility can easily lose their balance and fall. Limiting the gap between the bar and the wall to just 40mm prevents the forearm from getting trapped and significantly reduces the risk of fracture. Since they are closer to the wall, the grab bars require less space. This improves access within the sanitary facilities (showers, WCs, etc.) providing greater freedom of movement. The grab bars are also more discreet.

#### Optimised grip

The diameter of the grab bars available ensures an optimum grip regardless of the end-use of the products. For healthcare facilities or public buildings we recommend grab bars with a diameter of 32mm.

#### Tube thickness

The tubes used by DELABIE are generally thicker than most products available. It is an essential feature that attests to the high quality and strength of these products.

#### DELABIE's bead weld by "ArN-Securit"

The plate and tube are welded together using a bead weld so there is no need for a filler material (a process exclusive to "ArN-Securit"). The plate and the tube form a single, integrated structure particularly resistant to the mechanical stresses placed on grab bars.

#### Bending tubes with a mandrel

The tubes are bent with precision using a mandrel to prevent the metal from ovalising or stretching, ensuring a uniform thickness of the metal throughout the bend.

#### Concealed fixings

All fixings are concealed by a stainless steel cover plate.

### MAXIMUM HYGIENE

#### Stainless Steel: a material that limits bacterial proliferation

DELABIE's grab bars are made from bacteriostatic 304 stainless steel. With this type of stainless steel, a thin, invisible protective layer forms continuously when in contact with air or water.

Even if the surface is damaged mechanically, the stainless steel is protected against corrosion.

**The surface remains bright, hard and smooth, preventing bacteria from easily adhering to the surface.**

Bacterial development is therefore slower compared to other materials.

Studies have regularly proven the aseptic qualities of stainless steel. It is ideal for environments that demand high standards of hygiene (for example hospitals, retirement homes, schools and canteens).

“**Stainless steel cannot be overlooked when it comes to hygiene.**”

#### DELABIE's UltraPolish and UltraSatin finishes: cleaning is easy and sustainable

**UltraPolish** bright polished finish and **UltraSatin** polished satin finish provide the grab bars with a uniform, non-porous surface. They are easy to clean and require less cleaning product. Bacterial retention after cleaning is extremely low, up to 20 times less than for other materials such as glass or plastic.

Studies show that after several cycles of daily soiling and cleaning, polished stainless steel retains less dirt and fewer residual bacteria than copper which also has bactericidal properties. Copper surfaces degrade over time, making them more difficult to clean.

Polished stainless steel provides better hygiene by facilitating sustainable cleaning.

#### Fewer seams

Particular attention has been paid to the design of the grab bar and shower seats to reduce the number of joins and seams. This reduces the build-up of dirt and niches where bacteria can develop.

### AND ALSO...

#### 100% interchangeable

The fixing plates for the bars are indexed and the dimensions are checked during the manufacturing process. There is no need to drill additional holes in the wall if replacing the bar with an identical one.

#### 100% recyclable

Stainless steel is 100% recyclable, contributing to sustainable development and protecting the environment. DELABIE's stainless steel products contain 50-65% recycled stainless steel.

#### Complete range

Offering a wide range of products enables DELABIE to respond to the needs and requirements of the accessibility and independence sector. This offering complements DELABIE's other product ranges perfectly.

**TESTED TO OVER 200KG**  
**30-YEAR WARRANTY**  
**CE MARKED**

**40MM SAFETY GAP**  
Reduced risk of fracture  
Space saving

**SIGNIFICANT**  
**TUBE THICKNESS**  
High resistance

**TUBE Ø 32MM**  
Optimised grip

**FIXINGS CONCEALED**  
**BY STAINLESS STEEL COVER**  
**PLATE**

**FIXING PLATES ARE INDEXED**  
100% interchangeable

DELARIE

**BACTERIOSTATIC 304**  
**STAINLESS STEEL**  
Limits bacterial  
proliferation

**ULTRAPOLISH**  
**OR ULTRASATIN**  
**POLISHED**  
**FINISHES**  
Easy to clean



UltraPolish



UltraSatin

**100% RECYCLABLE**

**SEAM-FREE**  
No bacterial niches

ACCESSIBILITY  
STAINLESS STEEL





### Removable Comfort shower seat

To hang on grab bars



UltraPolish bright polished stainless steel structure



UltraSatin polished satin stainless steel structure

- **HR Comfort shower seat and backrest.**
- **Large model.**
- To hang on grab bars Ø 32mm (see ref.s 5481, 5120 and 50505 pages 101 - 103).
- **Anti-bacterial treatment** on seat and backrest: optimal protection against bacterial development.
- **Removable:** reduces the number of shower seats in a facility, allowing installation only when required e.g. hotels or hospitals providing short-term accommodation for people with reduced mobility.
- Suitable for intensive use in public places or the healthcare sector.
- Detachable solid seat made from high-strength polymer.
- Uniform non-porous surface for easy maintenance and hygiene.
- Good resistance to chemical products (Povidone-iodine) and cleaning.
- Anti-UV treatment.
- Warm to the touch.
- Bacteriostatic 304 stainless steel structure Ø 32mm.
- **Adjustable screw jacks guarantee a good horizontal position.**
- **Large protective caps prevent damage to the wall.**
- Dimensions: 590 × 420 × 510mm.
- Tested to over 200kg. Maximum recommended user weight: 135kg.
- 30-year warranty.
- CE marked.

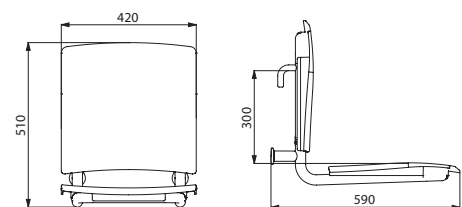

510300

Removable Comfort shower seat to hang on grab bars	
UltraPolish bright polished stainless steel structure	<b>510300</b>
UltraSatin polished satin stainless steel structure	<b>510300S</b>

**Lift-up shower seat**



- **HR Comfort shower seat and backrest.**
- **Large model.**
- **Anti-bacterial treatment** on seat and backrest: optimal protection against bacterial development.
- **Retained in upright position. Slowed down descent.**
- Suitable for intensive use in public places or the healthcare sector.
- Detachable solid seat made from high-strength polymer.
- Uniform non-porous surface for easy maintenance and hygiene.
- Good resistance to chemical products (Povidone-iodine) and cleaning.
- Anti-UV treatment.
- Warm to the touch.
- Bacteriostatic 304 stainless steel structure Ø 32mm.
- Concealed fixings, secured to wall by a 304 stainless steel plate, 4mm thick.
- Supplied with stainless steel screws for concrete walls.
- Seat dimensions: 506 × 420 × 138mm.
- Backrest dimensions: 56 × 420 × 410mm.
- Tested to over 200kg. Maximum recommended user weight: 135kg.
- 30-year warranty.
- CE marked.

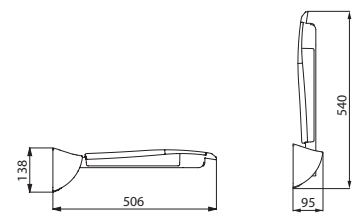

510420

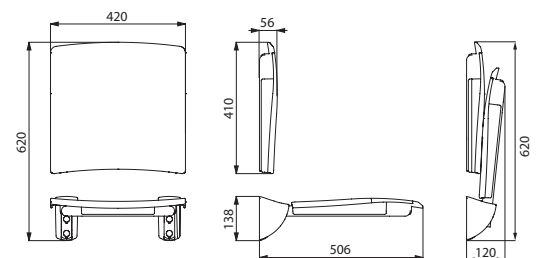

510420+510429

Lift-up Comfort shower seat - UltraPolish bright polished stainless steel structure	
Shower seat	<b>510420</b>
Backrest	<b>510429</b>
Lift-up Comfort shower seat - UltraSatin polished satin stainless steel structure	
Shower seat	<b>510420S</b>
Backrest	<b>510429S</b>

Lift-up shower seat with leg



ACCESSIBILITY  
STAINLESS STEEL

- HR Comfort shower seat and backrest.
- Large model.
- Anti-bacterial treatment on seat and backrest: optimal protection against bacterial development.
- Retained in upright position. Slowed down descent.
- Suitable for intensive use in public places or the healthcare sector.
- Detachable solid seat made from high-strength polymer.
- Uniform non-porous surface for easy maintenance and hygiene.
- Good resistance to chemical products (Povidone-iodine) and cleaning.
- Anti-UV treatment.
- Warm to the touch.
- Bacteriostatic 304 stainless steel structure Ø 32mm.
- Reinforced by a folding, articulated leg made from 304 stainless steel tube Ø 25mm.
- Concealed fixings, secured to wall by a 304 stainless steel plate, 4mm thick.
- Supplied with stainless steel screws for concrete walls.
- Seat dimensions: 506 × 420 × 480 mm.
- Backrest dimensions: 56 × 420 × 410 mm.
- Tested to over 250kg. Maximum recommended user weight: 170kg.
- 30-year warranty.
- CE marked.

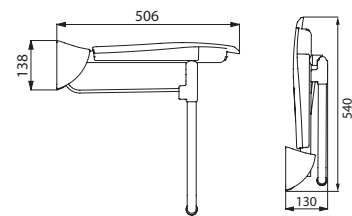

510430

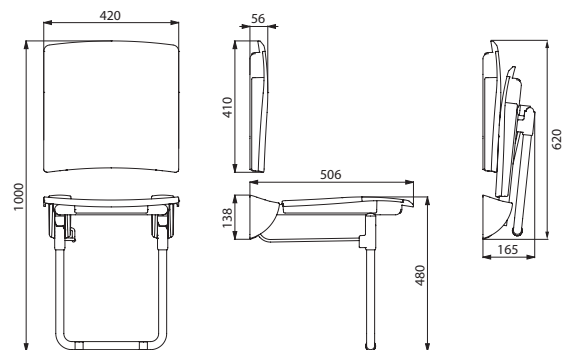

510430+510429

Lift-up Comfort shower seat with leg - UltraPolish bright polished stainless steel structure	
Shower seat with leg	510430
Backrest	510429
Lift-up Comfort shower seat with leg - UltraSatin polished satin stainless steel structure	
Shower seat with leg	510430S
Backrest	510429S



Straight grab bar

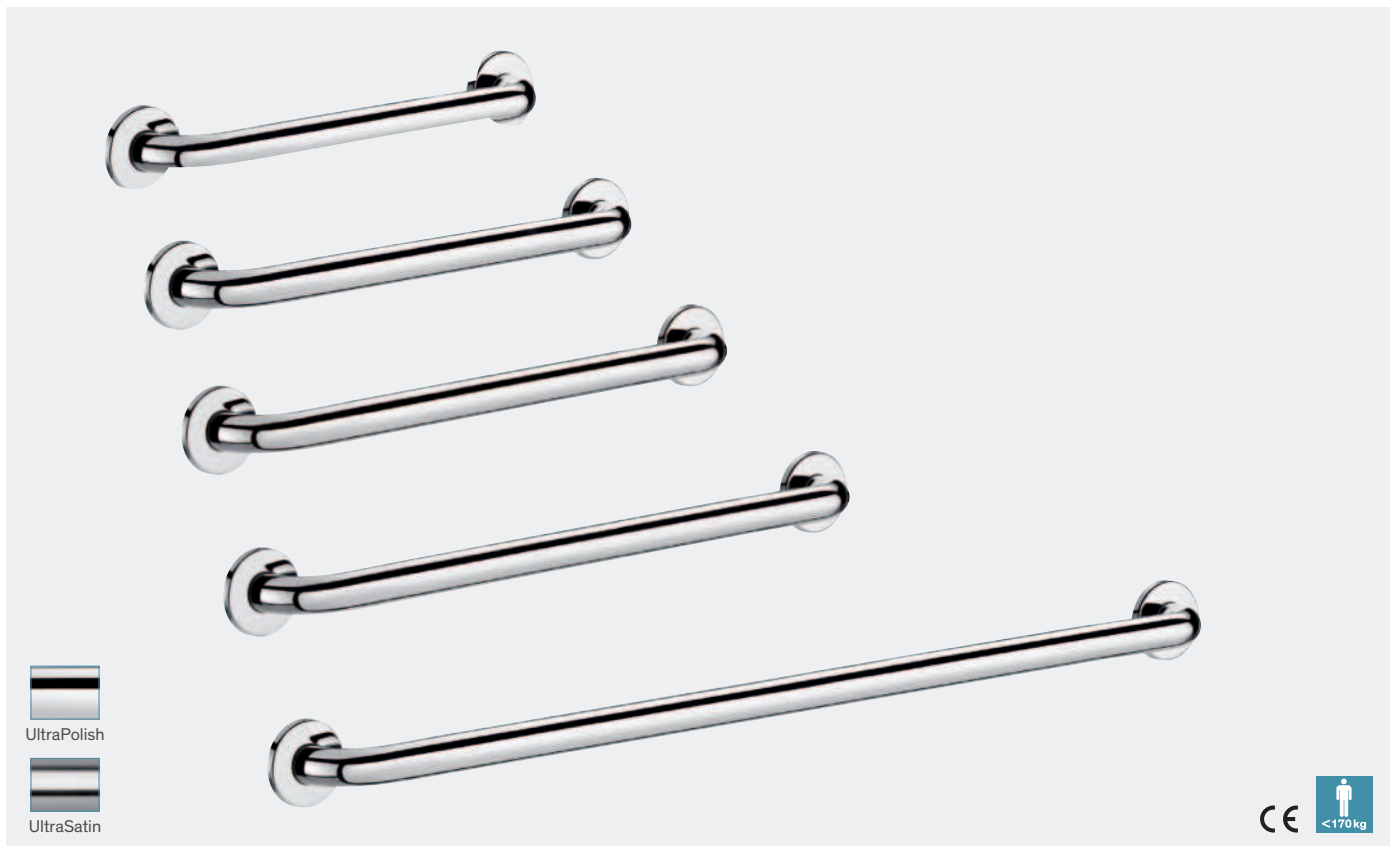

- For WCs, showers or baths.
- For use as a handrail, grab bar or support rail.
- Bacteriostatic 304 stainless steel tube.
- Stainless steel with UltraPolish bright polished finish or UltraSatin polished satin finish, uniform non-porous surface for easy maintenance and hygiene.
- Plate welded to the tube by invisible safety bead weld (process exclusive to "ArN-Securit").
- 40mm gap between the bar and the wall: minimal space prevents the forearm passing between the bar and the wall, reducing the risk of fracture in case of loss of balance.
- Concealed fixings, secured to wall by a 3-hole plate, Ø 72mm.  
Fixing plates and cover plates in 304 stainless steel.
- Supplied with stainless steel screws for concrete walls.
- Dimensions: 300 - 900mm centre-to-centre, Ø 32mm.
- Models 300 - 600mm: tested to over 250kg. Maximum recommended user weight: 170kg. Models 900mm: maximum recommended user weight: 135kg.
- 30-year warranty.
- CE marked.

Straight grab bar Ø 32mm - UltraPolish	
UltraPolish bright polished stainless steel - 300mm	<b>5050P2</b>
UltraPolish bright polished stainless steel - 400mm	<b>50504P2</b>
UltraPolish bright polished stainless steel - 500mm	<b>50505P2</b>
UltraPolish bright polished stainless steel - 600mm	<b>50506P2</b>
UltraPolish bright polished stainless steel - 900mm	<b>50509P2</b>
Straight grab bar Ø 32mm - UltraSatin	
UltraSatin polished satin stainless steel - 300mm	<b>5050S</b>
UltraSatin polished satin stainless steel - 400mm	<b>50504S</b>
UltraSatin polished satin stainless steel - 500mm	<b>50505S</b>
UltraSatin polished satin stainless steel - 600mm	<b>50506S</b>
UltraSatin polished satin stainless steel - 900mm	<b>50509S</b>

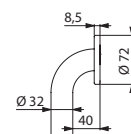

5050/50504  
50505/50506/50509

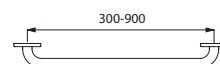

5050/50504/50505/50506/50509



Angled grab bar 135° **5082S** - 700 S PMR WC **110710** - Backrest **510629S** - TEMPOMATIC electronic direct flush WC valve **463150**  
Drop-down support rail **510164S** - Toilet brush set with ergonomic handle **4051S + 4051M**

## Angled grab bar 135°

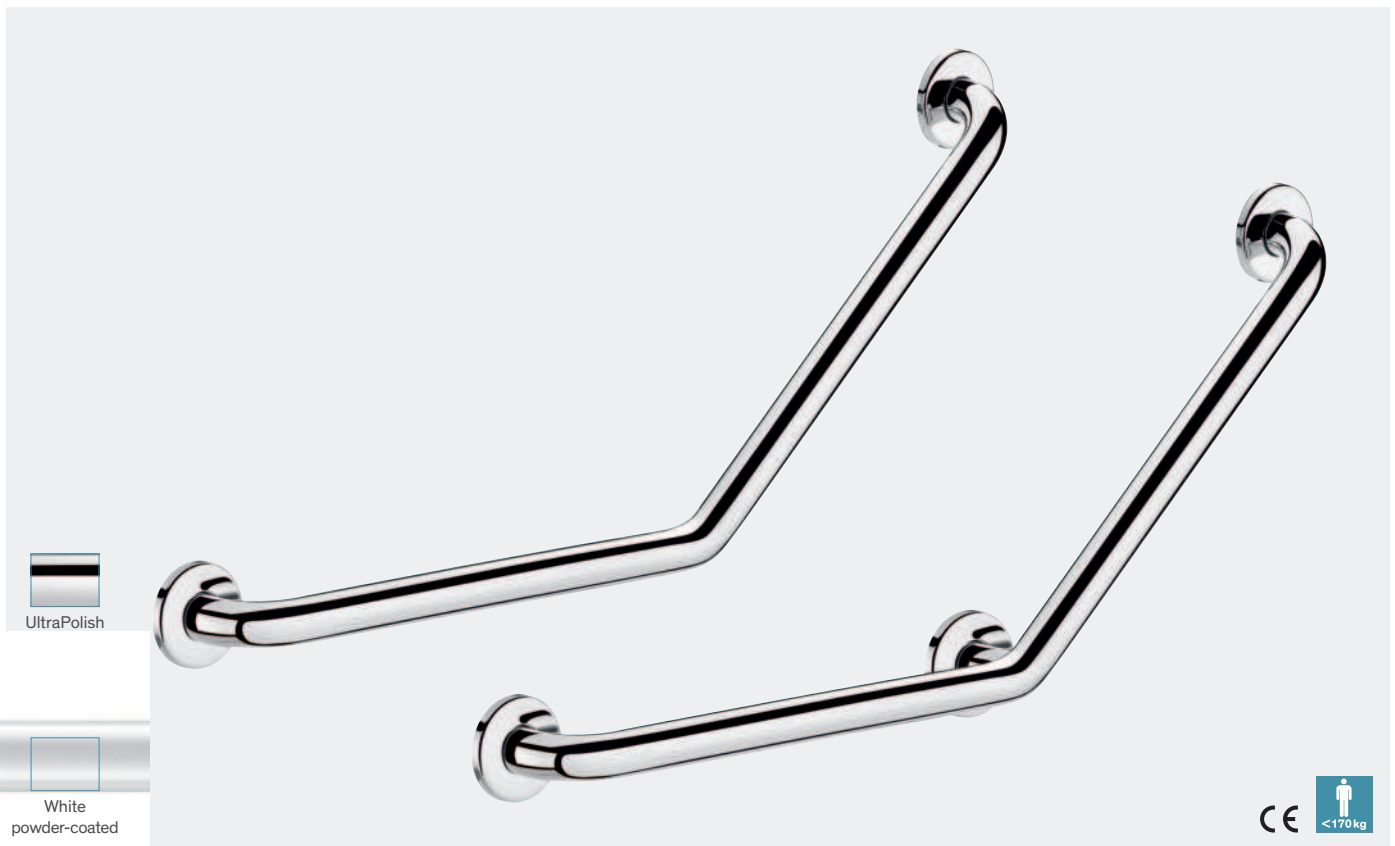

ACCESSIBILITY  
STAINLESS STEEL

- For WCs, showers or baths.
- For use as a handrail (horizontal part) or as a grab bar (135° part).
- Universal for either left or right side.
- Bacteriostatic 304 stainless steel tube.
- Stainless steel with UltraPolish bright polished finish or UltraSatin polished satin finish, uniform non-porous surface for easy maintenance and hygiene.
- Plate welded to the tube by invisible safety bead weld (process exclusive to "ArN-Securit").
- 40mm gap between the bar and the wall: minimal space prevents the forearm passing between the bar and the wall, reducing the risk of fracture in case of loss of balance.
- Models with 3 fixing points: prevents the hand from getting trapped and simplifies installation.
- Concealed fixings, secured to wall by a 3-hole plate, Ø 72mm. Fixing plates and cover plates in 304 stainless steel.
- Supplied with stainless steel screws for concrete walls.
- Dimensions: 400 × 400mm or 220 × 220mm.
- Models with 3 fixing points, Ø 32mm: tested to over 250kg, max. recommended user weight: 170kg. Models with 2 fixing points, Ø 32mm: max. recommended user weight: 135kg. Ø 25mm models: max. recommended user weight: 115kg.
- 30-year warranty. CE marked.

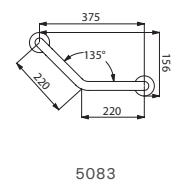
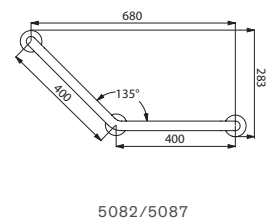
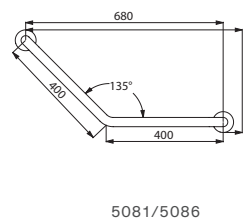
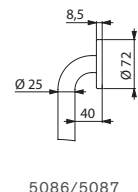
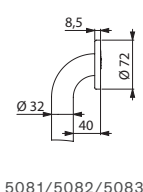

Angled grab bar 135° 2 fixing points - Ø 32mm	
UltraPolish bright polished stainless steel - 400 × 400mm	<b>5081P2</b>
UltraPolish bright polished stainless steel - 220 × 220mm	<b>5083P</b>
UltraSatin polished satin stainless steel - 400 × 400mm	<b>5081S</b>
UltraSatin polished satin stainless steel - 220 × 220mm	<b>5083S</b>
Angled grab bar 135° 3 fixing points - Ø 32mm	
UltraPolish bright polished stainless steel - 400 × 400mm	<b>5082P</b>
UltraSatin polished satin stainless steel - 400 × 400mm	<b>5082S</b>
White powder-coated stainless steel - 400 × 400mm	<b>5082W</b>
Angled grab bar 135° 2 fixing points - Ø 25mm	
UltraPolish bright polished stainless steel - 400 × 400mm	<b>5086P2</b>
Angled grab bar 135° 3 fixing points - Ø 25mm	
UltraPolish bright polished stainless steel - 400 × 400mm	<b>5087P</b>



Drop-down support rail **510164S** - Angled grab bar 135° **5082S** - 700 S PMR WC **110710** - TEMPOMATIC electronic direct flush WC valve **463150**



## Drop-down support rail

With concealed fixings

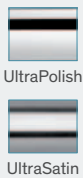

- For WCs or showers.
- Allows side access in the raised position.
- In the lowered position use as a grab bar, as a support for standing and for assisting movement.
- Slowed down descent. Retained in upright position.
- Bacteriostatic 304 stainless steel tube.
- Stainless steel with UltraPolish bright polished finish or UltraSatin polished satin finish, uniform non-porous surface for easy maintenance and hygiene.
- Concealed fixings, secured to wall by a 304 stainless steel plate, 4mm thick.
- Supplied with stainless steel screws for concrete walls.
- Models with leg: **to be used as reinforcement when the wall fixing alone is insufficient.** Leg folds automatically. Leg height can be adjusted from 760 - 780mm. Dimensions: 850 or 650 × 800 × 105mm, Ø 32mm.
- Models without leg: 850 or 650 × 230 × 105mm, Ø 32mm.
- Models with leg: **tested to over 250kg, maximum recommended user weight 170kg.** Model without leg: tested to over 200kg, maximum recommended user weight 135kg.
- 30-year warranty.
- CE marked.

### Additional products



Backrest for WCs and toilet roll holder (see pages 105 & 107)

### Related product



- Cover plate**
- Conceals the fixing screws when the drop-down support rail is removed.
  - Reduces the number of rails in a facility, allowing installation only when required.
  - Supplied with stainless steel screws for concrete walls.
  - 30-year warranty.

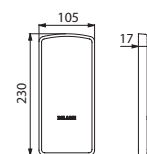

510150

Chrome-plated cover with fixing plate

510150

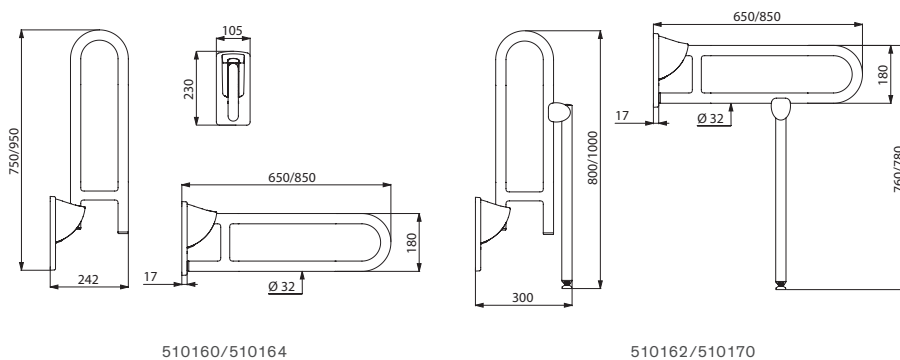

Drop-down support rail with concealed fixings Ø 32mm without leg	
UltraPolish bright polished stainless steel - L. 650mm	510160P
UltraPolish bright polished stainless steel - L. 850mm	510164P
UltraSatin polished satin stainless steel - L. 650mm	510160S
UltraSatin polished satin stainless steel - L. 850mm	510164S
Drop-down support rail with concealed fixings Ø 32mm with leg	
UltraPolish bright polished stainless steel - L. 650mm	510162P
UltraPolish bright polished stainless steel - L. 850mm	510170P
UltraSatin polished satin stainless steel - L. 650mm	510162S
UltraSatin polished satin stainless steel - L. 850mm	510170S

Straight bar with sliding shower head holder

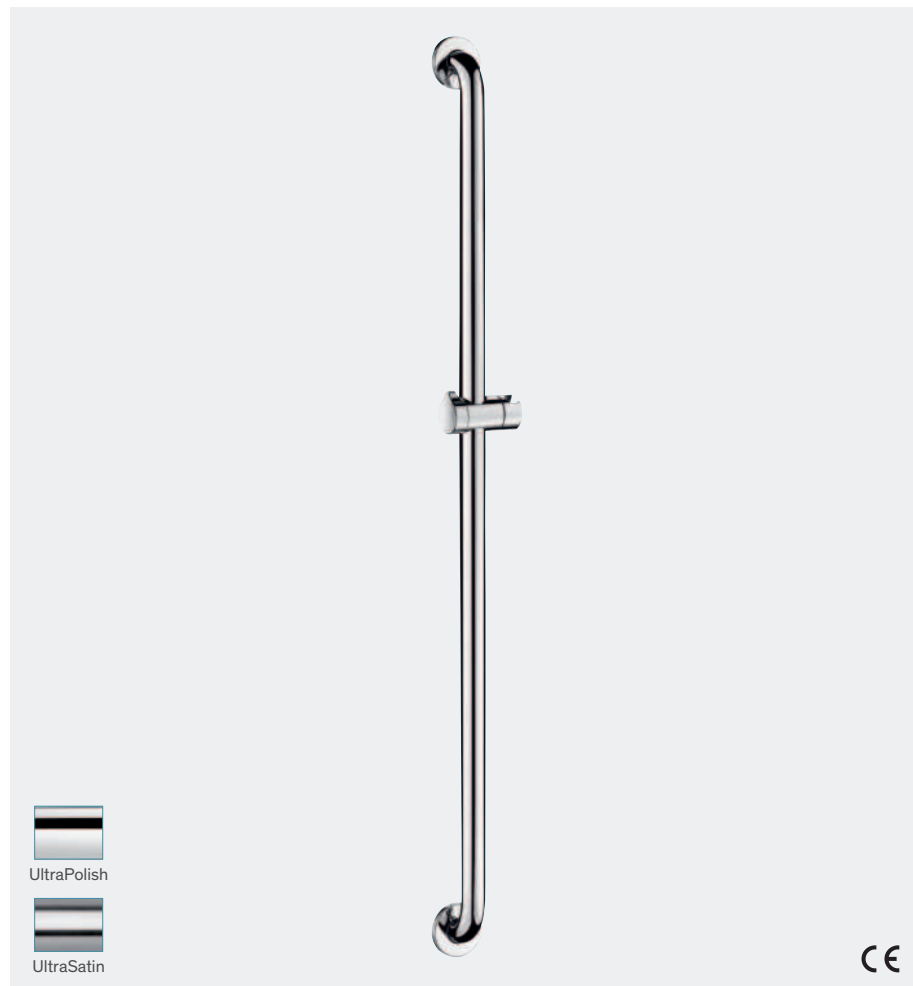

Additional products



Sliding soap dish and shower head  
(see pages 104 & 105)

- For showers or baths.
- Can be used as a vertical grab bar and shower head riser rail.
- Chrome-plated metal sliding shower head holder with ergonomic locking ring.
- Sliding soap dish can be added (order separately).
- Bacteriostatic 304 stainless steel tube.
- Stainless steel with UltraPolish bright polished finish or UltraSatin polished satin finish, uniform non-porous surface for easy maintenance and hygiene.
- Plate welded to the tube by invisible safety bead weld (process exclusive to "ArN-Securit").
- 40mm gap between the bar and the wall:  
minimal space prevents the forearm passing between the bar and the wall, reducing the risk of fracture in case of loss of balance.
- Concealed fixings, secured to wall by a 3-hole plate, Ø 72mm.  
Fixing plates and cover plates in 304 stainless steel.
- Supplied with stainless steel screws for concrete walls.
- Height: 1,150mm, Ø 32mm.
- Tested to over 200kg. Maximum recommended user weight: 135kg.
- 30-year warranty.
- CE marked.

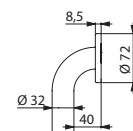

5460

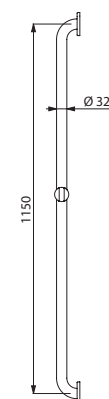

5460

Straight bar Ø 32mm with sliding shower head holder	
UltraPolish bright polished stainless steel	5460P2
UltraSatin polished satin stainless steel	5460S

## T-shaped grab bar



### Additional products



Sliding shower head holders, sliding soap dish and shower shelf with glove holder (see pages 104 & 105)

- For showers.
- Use as a grab bar and to support the user in an upright position.
- Helps and secures entry and movement in the shower.
- Use as a shower riser rail by adding a sliding shower head holder and/or soap dish.
- Models with sliding riser rail: **upright position can be adjusted during installation.**  
Can be moved to the left or the right in order to adapt the space (positioning of shower, depth of shower seat...).
- Bacteriostatic 304 stainless steel tube.
- Stainless steel with UltraPolish bright polished finish or UltraSatin polished satin finish, uniform non-porous surface for easy maintenance and hygiene.
- Plate welded to the tube by invisible safety bead weld (process exclusive to "ArN-Securit").
- 40mm gap between the bar and the wall: minimal space prevents the forearm passing between the bar and the wall, reducing the risk of fracture in case of loss of balance.
- Concealed fixings, secured to wall by a 3-hole plate, Ø 72mm. Fixing plates and cover plates in 304 stainless steel.
- Supplied with stainless steel screws for concrete walls.
- Dimensions: 1,160 or 1,150 × 500mm, Ø 32mm.
- Tested to over 200kg. Maximum recommended user weight: 135kg.
- 30-year warranty. CE marked.

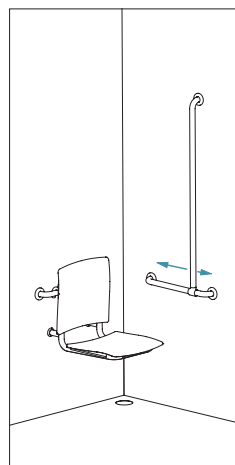

Position of upright can be adjusted (Ref. 5441)

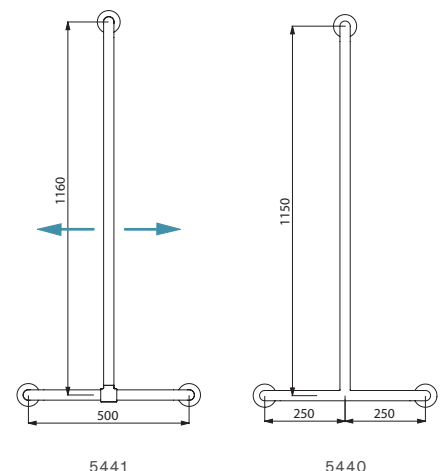
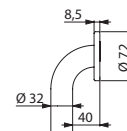

T-shaped grab bar Ø 32mm with sliding vertical riser rail	
UltraPolish bright polished stainless steel	5441P
UltraSatin polished satin stainless steel	5441S
T-shaped grab bar Ø 32mm	
UltraPolish bright polished stainless steel	5440P2
UltraSatin polished satin stainless steel	5440S



L-shaped grab bar **5071GP2** - Shower head holder **4110P** - Lift-up Comfort shower seat and backrest **510420 + 510429** - Thermostatic shower mixer **H9769**

## L-shaped grab bar



### Additional products

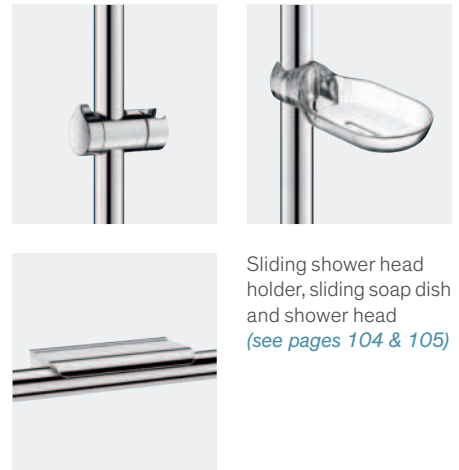

- For showers or baths.
- Helps the user stand and move safely in the shower or bath.
- Use as a shower rail by adding a sliding shower head holder and/or soap dish.
- Bacteriostatic 304 stainless steel tube.
- Stainless steel with UltraPolish bright polished finish or UltraSatin polished satin finish, uniform non-porous surface for easy maintenance and hygiene.
- Plate welded to the tube by invisible safety bead weld (process exclusive to "ArN-Securit").
- 40mm gap between the bar and the wall: minimal space prevents forearm passing between the bar and the wall, reducing the risk of fracture in case of loss of balance.
- Concealed fixings secured to wall by a 3-hole fixing plate,  $\varnothing 72$ mm. Fixing plates and cover plates in 304 stainless steel.
- Supplied with stainless steel screws for concrete walls.
- Dimensions: 1,150 or 750 x 450mm,  $\varnothing 32$ mm.
- Tested to over 200kg. Maximum recommended user weight: 135kg.
- 30-year warranty.
- CE marked.

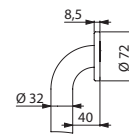

5070/5071

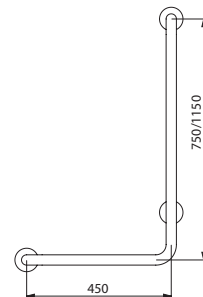

Left model  
5070G/5071G

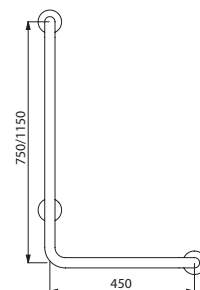

Right model  
5070D/5071D

L-shaped grab bar $\varnothing 32$ mm - Height 750mm	
UltraPolish bright polished stainless steel - Left model	<b>5070GP2</b>
UltraPolish bright polished stainless steel - Right model	<b>5070DP2</b>
UltraSatin polished satin stainless steel - Left model	<b>5070GS</b>
UltraSatin polished satin stainless steel - Right model	<b>5070DS</b>
L-shaped grab bar $\varnothing 32$ mm - Height 1,150mm	
UltraPolish bright polished stainless steel - Left model	<b>5071GP2</b>
UltraPolish bright polished stainless steel - Right model	<b>5071DP2</b>
UltraSatin polished satin stainless steel - Left model	<b>5071GS</b>
UltraSatin polished satin stainless steel - Right model	<b>5071DS</b>



Removable Comfort shower seat **510300** - Two-wall corner grab bar with vertical riser rail **5481DP2** - Sliding shower head holder **4110P**  
Recessed SECURITHERM sequential thermostatic mixer **H96CBOX+H9633** - Shower head **813** - SILVER flexible hose **836T3**

## Two-wall grab bar with vertical riser rail

For shower seats



### Additional products



Removable shower seat (see page 87), sliding shower head holders and sliding soap dish (see pages 104 & 105)

- For showers.
- Can support a removable shower seat (order separately).
- Use as a grab bar and to support the user in an upright position.
- Helps and secures entry and movement in the shower.
- Use as a shower riser rail by adding a sliding shower head holder and/or soap dish.
- Models with sliding riser rail: upright position can be adjusted during installation. Can be moved to the left or the right in order to adapt the space (positioning of shower, depth of shower seat...).
- Can be installed with the upright on the left or the right.
- Bacteriostatic 304 stainless steel tube.
- Stainless steel with UltraPolish bright polished finish or UltraSatin polished satin finish, uniform non-porous surface for easy maintenance and hygiene.
- Plate welded to the tube by invisible safety bead weld (process exclusive to "ArN-Securit").
- 40mm gap between the bar and the wall: minimal space prevents the forearm passing between the bar and the wall, reducing the risk of fracture in case of loss of balance.
- Concealed fixings, secured to wall by a 3-hole plate, Ø 72mm. Fixing plates and cover plates in 304 stainless steel.
- Supplied with stainless steel screws for concrete walls.
- Dimensions: 1,160 or 1,150 × 750 × 750mm, Ø 32mm.
- Tested to over 200kg. Maximum recommended user weight: 135kg.
- 30-year warranty. CE marked.

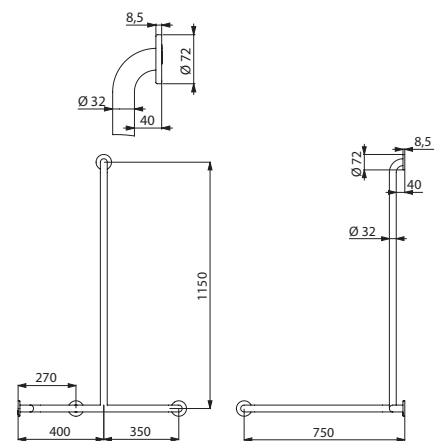

Right model - 5481D

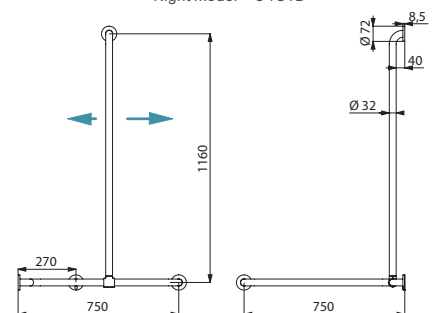

5481

Two-wall corner grab bar with vertical riser rail Ø 32mm for shower seats - Sliding riser rail	
UltraPolish bright polished stainless steel	5481P
UltraSatin polished satin stainless steel	5481S
Two-wall corner grab bar with vertical riser rail Ø 32mm for shower seats - Fixed riser rail	
UltraPolish bright polished stainless steel - Left model	5481GP2
UltraPolish bright polished stainless steel - Right model	5481DP2
UltraSatin polished satin stainless steel - Left model	5481GS
UltraSatin polished satin stainless steel - Right model	5481DS

**Two-wall corner grab bar**

For shower seats



- For WCs, showers or baths.
- Can support a removable shower seat (order separately).
- Use as a grab bar and to support the user in an upright position.
- Helps and secures entry and movement in the shower or bath.
- Helps with the transfer from a wheelchair to the toilet seat for WCs with recessed cisterns or direct flush.
- Bacteriostatic 304 stainless steel tube.
- Stainless steel with UltraPolish bright polished finish or UltraSatin polished satin finish, uniform non-porous surface for easy maintenance and hygiene.
- Plate welded to the tube by invisible safety bead weld (process exclusive to "ArN-Securit").
- 40mm gap between the bar and the wall:  
minimal space prevents the forearm passing between the bar and the wall, reducing the risk of fracture in case of loss of balance.
- Concealed fixings, secured to wall by a 3-hole plate, Ø 72mm.  
Fixing plates and cover plates in 304 stainless steel.
- Supplied with stainless steel screws for concrete walls.
- Dimensions: 750 × 750mm, Ø 32mm.
- Tested to over 200kg. Maximum recommended user weight: 135kg.
- 30-year warranty.
- CE marked.

**Additional products**

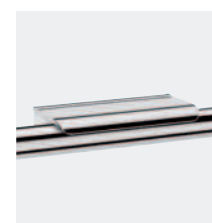

Removable shower seat (see page 87) and shower shelf with glove holder (see page 105)

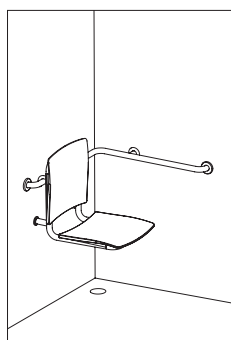

Installation example for showers

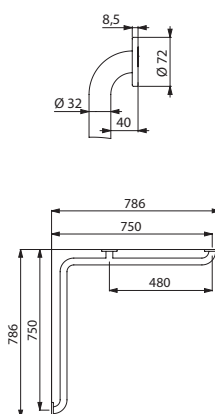

5120

Two-wall corner grab bar Ø 32mm for shower seats	
UltraPolish bright polished stainless steel	5120P2
UltraSatin polished satin stainless steel	5120S



## Single grab bar

For shower seats



- For showers.
- Can support a removable shower seat (order separately).
- For use as a grab bar and to support the user in an upright position.
- Helps and secures entry and movement in the shower.
- Bacteriostatic 304 stainless steel tube.
- Stainless steel with UltraPolish bright polished finish or UltraSatin polished satin finish, uniform non-porous surface for easy maintenance and hygiene.
- Plate welded to the tube by invisible safety bead weld (process exclusive to "ArN-Securit").
- 40mm gap between the bar and the wall: minimal space prevents the forearm passing between the bar and the wall, reducing the risk of fracture in case of loss of balance.
- Concealed fixings, secured to wall by a 3-hole plate, Ø 72mm. Fixing plates and cover plates in 304 stainless steel.
- Supplied with stainless steel screws for concrete walls.
- Dimensions: 500mm, Ø 32mm.
- Tested to over 250kg. Maximum recommended user weight: 170kg.
- 30-year warranty.
- CE marked.

## Additional product



Removable shower seat (see page 87)

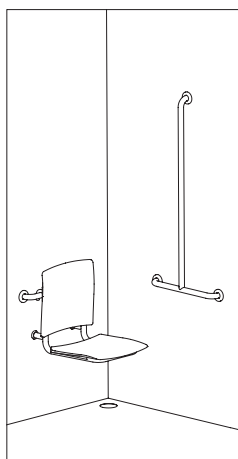

Installation example for showers

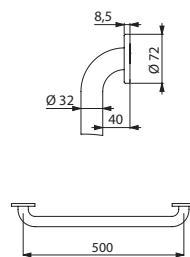

50505

### Grab bar Ø 32mm for shower seats

UltraPolish bright polished stainless steel	<b>50505P2</b>
UltraSatin polished satin stainless steel	<b>50505S</b>

### Nylon sliding shower head holder

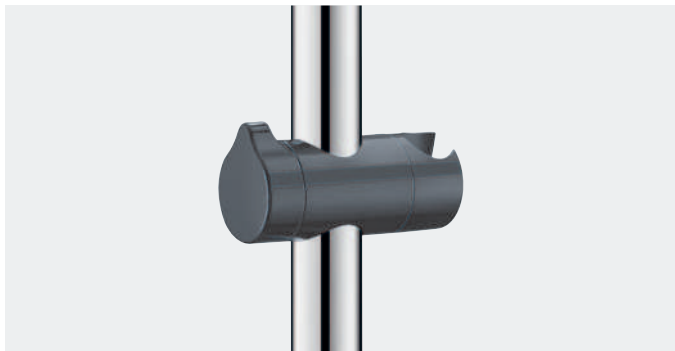

- High-strength polyamide (Nylon).
- Support for adjustable shower heads.
- Ergonomic locking ring.
- **For Ø 32mm grab bars**  
(see ref.s 5441, 5440 and 5481 pages 97 & 101).
- 30-year warranty.

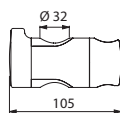

510110NG

Sliding shower head holder - Nylon HR bright anthracite grey 510110NG

### Chrome-plated sliding shower head holder



- **Fixes separately onto the bar and can be added after installation.**
- Support for adjustable shower heads.
- Ergonomic locking ring.
- **For Ø 25 and Ø 32mm grab bars.**
- 30-year warranty.

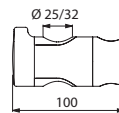

4110P

Chrome-plated metal - sliding shower head holder 4110P

### Shower head



- M $\frac{1}{2}$ " shower head in chrome-plated ABS.
- Monojet: rain effect.
- Manual system for removing limescale.
- 30-year warranty.

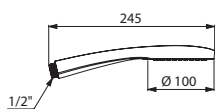

815

Rain effect shower head 815

### Shower head retaining collar



- For Ø 25 - 35mm rails and flexible shower hose.
- **Retaining device:** prevents shower head from coming into direct contact with the floor or floor trap (source of bacterial contamination).
- 30-year warranty.

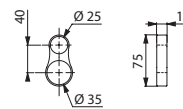

830

Translucent shower head retaining collar 830

### Clip-on sliding soap dish



- Soap dish for shower gel or soap.
- For  $\varnothing 25$  and  $\varnothing 32$ mm riser rails.
- 30-year warranty.

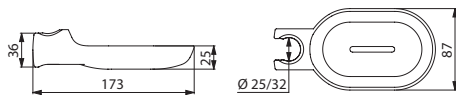

510120

Translucent clip-on soap dish

510120

### Shower shelf for grab bars

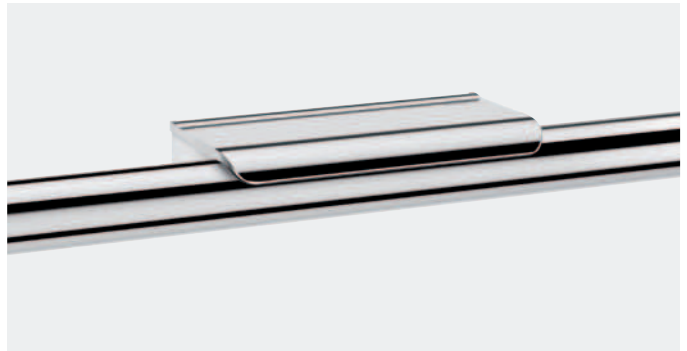

- Place against the wall, on the grab bar.
- **Anti-theft lock.**
- Suitable for shower gel or soap.
- **2 hooks for gloves.**
- 30-year warranty.

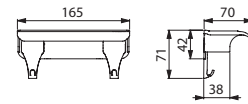

511922P

Chrome-plated shower shelf for grab bars

511922P

### Nylon toilet roll holder for grab bars



- For toilet rolls.
- Can be fitted without removing grab bar.
- Anti-theft lock.
- Anti-rotating locking feature.
- For  $\varnothing 32$ mm to  $\varnothing 34$ mm bars.
- 30-year warranty.

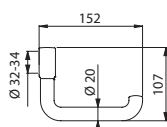

510081

Toilet roll holder for grab bars  
HR Nylon bright anthracite grey

510081

### Chrome-plated toilet roll holder for grab bars



- For toilet rolls.
- Can be fitted without removing grab bar.
- Anti-theft lock.
- Anti-rotating locking feature.
- For  $\varnothing 32$ mm bars.
- 30-year warranty.

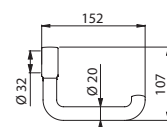

510081P

Toilet roll holder for grab bars  
Chrome-plated

510081P

**U-shaped toilet roll holder**

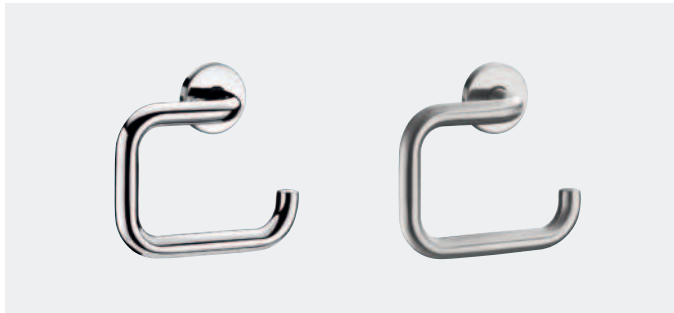

- **Bacteriostatic 304 stainless steel.**
- Tube Ø 20mm, 1mm thick.
- **Concealed fixings.**
- 30-year warranty.

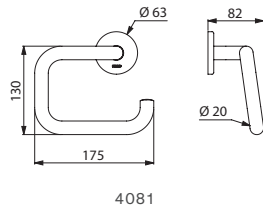

4081

<b>U-shaped toilet roll holder</b>	
Bright polished 304 stainless steel	<b>4081P</b>
Polished satin 304 stainless steel	<b>4081S</b>

**Toilet roll holder or for spares**

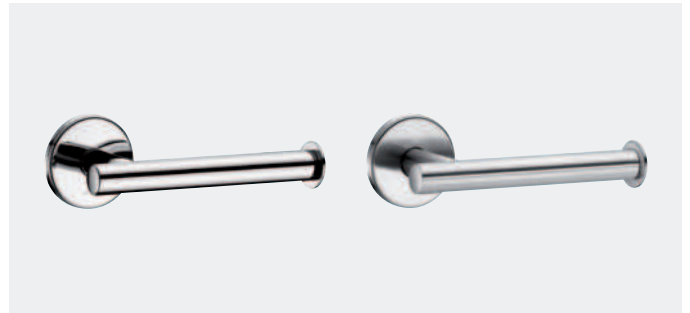

- **Bacteriostatic 304 stainless steel.**
- Can be installed horizontally for **main use**, or vertically as a **spare toilet roll holder**.
- Tube Ø 20mm, 1mm thick.
- **Concealed fixings.**
- 30-year warranty.

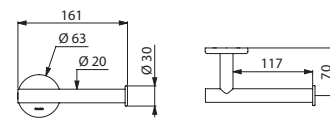

510083

<b>Toilet roll holder or for spares</b>	
Bright polished 304 stainless steel	<b>510083P</b>
Polished satin 304 stainless steel	<b>510083S</b>

**Spare toilet roll holder**

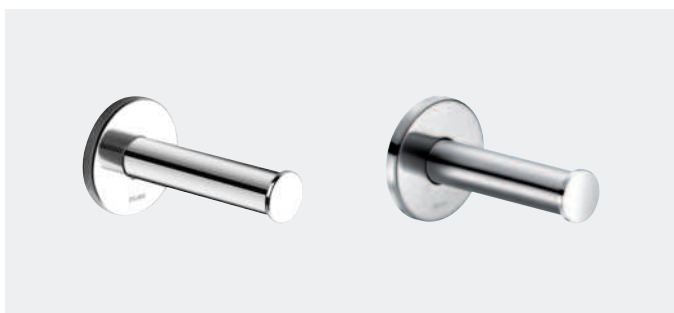

- **Bacteriostatic 304 stainless steel.**
- Tube Ø 25mm, 1.2mm thick.
- **Concealed fixings.**
- 30-year warranty.

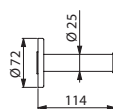

4070

<b>Spare toilet roll holder</b>	
Bright polished 304 stainless steel	<b>4070P</b>
Polished satin 304 stainless steel	<b>4070S</b>

**Twin toilet roll holder**



- **Bacteriostatic 304 stainless steel.**
- For two toilet rolls.
- Tube Ø 20mm, 1mm thick.
- **Concealed fixings.**
- 30-year warranty.

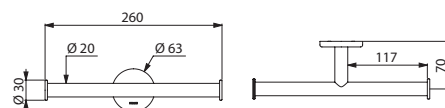

510082

<b>Twin toilet roll holder</b>	
Bright polished 304 stainless steel	<b>510082P</b>
Polished satin 304 stainless steel	<b>510082S</b>

### Coat hook



- **Bacteriostatic 304 stainless steel.**
- Tube Ø 20mm, 1mm thick.
- Short model: L. 65mm.  
Long model: L. 100mm.
- **Concealed fixings.**
- 30-year warranty.

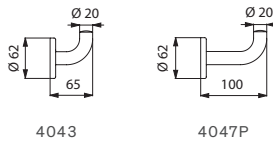

Coat hook - Short model	
Bright polished 304 stainless steel	<b>4043P</b>
Polished satin 304 stainless steel	<b>4043S</b>
Coat hook - Long model	
Bright polished 304 stainless steel	<b>4047P</b>

### Stainless steel "Disabled" signs

Self-adhesive

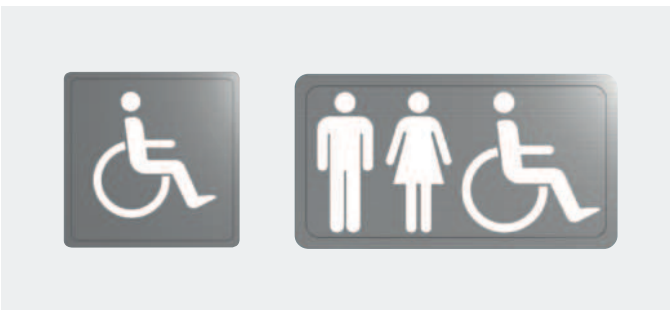

- **Polished satin 304 stainless steel.**
- Stainless steel thickness: 1.2mm.
- Dimensions: 125 or 230 × 125 mm.
- 30-year warranty.

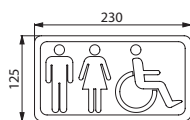

510155S

304 stainless steel toilet sign	
Disabled sign	<b>510153S</b>
Mixed disabled sign	<b>510155S</b>

### Double coat hook



- **Bacteriostatic 304 stainless steel.**
- Tube Ø 20mm, 1mm thick.
- **Concealed fixings.**
- 30-year warranty.

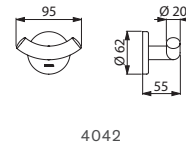

4042

Double coat hook	
Bright polished 304 stainless steel	<b>4042P</b>
Polished satin 304 stainless steel	<b>4042S</b>

### Comfort backrest for WCs



- Backrest made from soft polyurethane.
- Bacteriostatic 304 stainless steel tube, Ø 25 × 1.2mm.
- Concealed fixings, secured to wall by a 3-hole plate, Ø 72mm. Fixing plates and cover plates in 304 stainless steel.
- Dimensions: 150 × 580 × 173mm.
- 30-year warranty.
- CE marked.

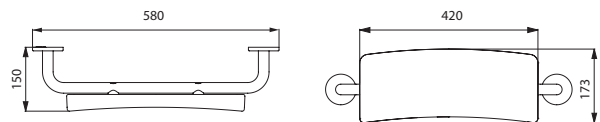

510629

Comfort backrest for WCs	
UltraPolish bright polished 304 stainless steel structure	<b>510629</b>
UltraSatin polished satin 304 stainless steel structure	<b>510629S</b>

ACCESSIBILITY  
STAINLESS STEEL

**Toilet brush set without lid**

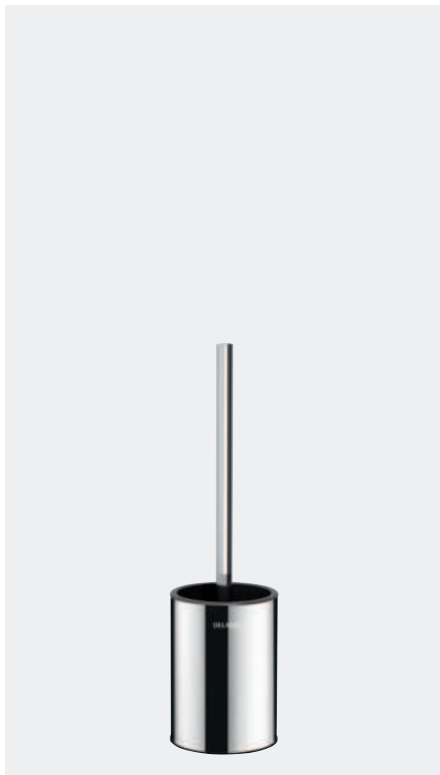

- **Robust model.**
- **Bacteriostatic 304 stainless steel.**
- Wall-mounted or floor-standing.
- Easy to clean: plastic bowl can be removed from above.
- **Plastic bowl with reservoir:** prevents toilet brush sitting in residual water and reduces the risk of splashing when next used.
- **Anti-theft lock** (wall-mounted model).
- Stainless steel thickness: 1mm body.
- Dimensions: Ø 90 × 330mm.
- 30-year warranty.

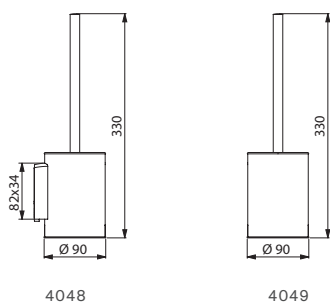

<b>Wall-mounted toilet brush set without lid</b>	
<b>Anti-theft lock</b>	
Bright polished 304 stainless steel	<b>4048P</b>
Polished satin 304 stainless steel	<b>4048S</b>
<b>Floor-standing toilet brush set without lid</b>	
Bright polished 304 stainless steel	<b>4049P</b>
Polished satin 304 stainless steel	<b>4049S</b>

**Toilet brush set with lid**



- **Robust model.**
- **Bacteriostatic 304 stainless steel.**
- Wall-mounted or floor-standing.
- **Ergonomic handle extension possible:** easy for wheelchair users or those with difficulty bending to use.
- Easy to clean: plastic bowl can be removed from above.
- **Plastic bowl with reservoir:** prevents toilet brush sitting in residual water and reduces the risk of splashing when next used.
- Toilet brush **automatically centres itself** in the holder.
- **Anti-theft lock** (wall-mounted model).
- Stainless steel thickness: 1mm body.
- Dimensions: Ø 90 × 410mm.
- 30-year warranty.

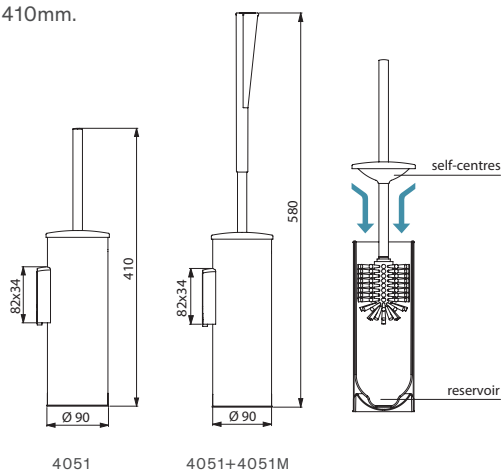

<b>Wall-mounted toilet brush set with lid - Anti-theft lock</b>	
Bright polished 304 stainless steel	<b>4051P</b>
Polished satin 304 stainless steel	<b>4051S</b>
<b>Floor-standing toilet brush set with lid</b>	
Bright polished 304 stainless steel	<b>4050P</b>
Polished satin 304 stainless steel	<b>4050S</b>
<b>Ergonomic extension for toilet brush handle</b>	<b>4051M</b>

### 1-metre stainless steel mirror

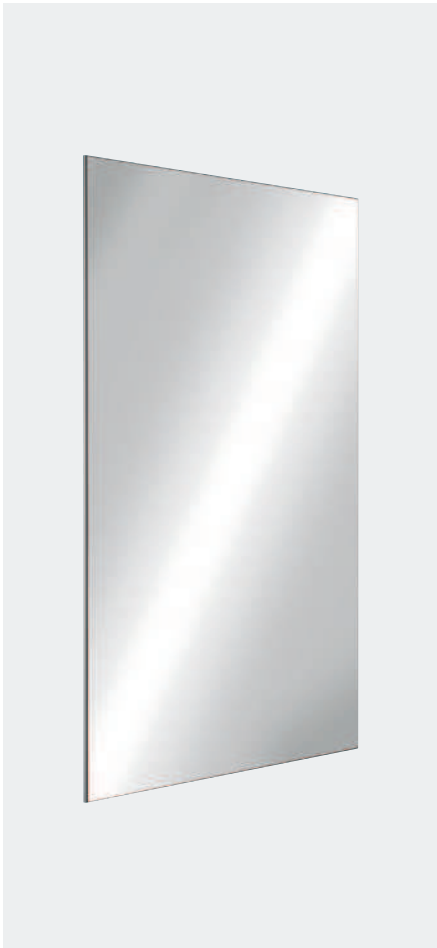

- **For combined installation:** height enables use from sitting or standing position.
- **"Mirror" polished** bacteriostatic 304 stainless steel.
- **Reinforced by a concealed solid PVC plate** 10mm thick.
- 5 fixing points. Concealed fixings.
- **Unbreakable.**
- Install on a flat surface.
- Dimensions : 10 × 595 × 980 mm.
- 30-year warranty.

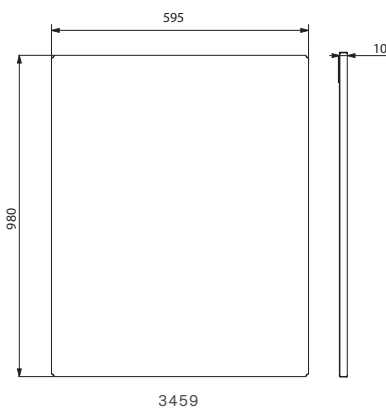

<b>Stainless steel unbreakable mirror</b>	<b>3459</b>
---	-------------

For more mirrors and studded pegs see pages 44 - 45.

### Tilting mirror

Long, ergonomic lever



- **For combined installation:** can be used from sitting or standing position.
- **Long, ergonomic lever for easy adjustment of mirror angle from a sitting position or from a wheelchair.**
- **Quick and easy to install:** simply clip into place.
- **Anti-theft lock.**
- Bright white HR Nylon lever.
- Mirror made from 6mm laminated safety glass.
- Can be tilted up to 20°.
- Mirror dimensions: 500 × 600mm.
- 30-year warranty.

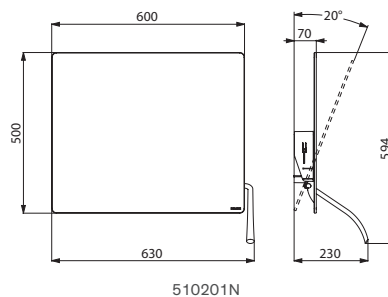
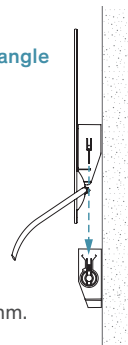

510201N

<b>Tilting mirror with long, ergonomic lever</b>	<b>510201N</b>
--	----------------

For more mirrors and studded pegs see pages 44 - 45.

### Tilting mirror

Tab handle



- **For combined installation:** can be used from sitting or standing position.
- **Tab handle for easy adjustment of mirror angle for those in a sitting position or for wheelchair users.**
- **Quick and easy to install:** simply clip into place.
- **Anti-theft lock.**
- Mirror made from 6mm laminated safety glass.
- Can be tilted up to 20°.
- Mirror dimensions: 500 × 600mm.
- 30-year warranty.

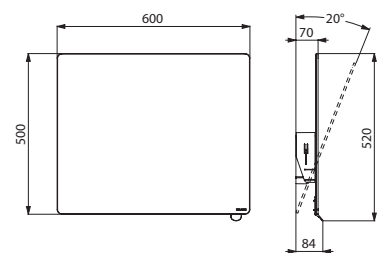
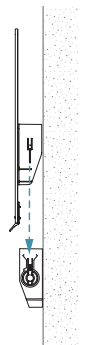

510202

<b>Tilting mirror with tab handle</b>	
Chrome-plated bright tab	<b>510202P</b>
Chrome-plated satin tab	<b>510202S</b>

For more mirrors and studded pegs see pages 44 - 45.

**700 PMR WC**

Wall-hung or floor-standing



- 700mm **elongated pan** for improved comfort for people with reduced mobility.
- Wall-hung model: compatible with all standard frame systems available on the market.
- Elegant and simple design.
- **Bacteriostatic 304 stainless steel.**
- Stainless steel thickness: 1.5mm.
- One-piece pressed WC bowl, seam-free for easy maintenance and better hygiene.
- WC bowl surface is polished with rounded edges for easy cleaning.
- Concealed perimetral flushing rim.
- Horizontal water inlet: Ø 55mm.
- Horizontal waste outlet: Ø 100mm.
- Water saving: works with 4L or more of water.
- Pre-drilled holes for fixing the toilet seat. Supplied with stainless steel blanking caps when installed without toilet seat lid.
- Quick and easy to install.
- Weight: 14.5kg for the 700 S model; 15kg for the 700 P model.
- 30-year warranty.
- CE marked. Complies with European standard EN 997 for 4L flush.

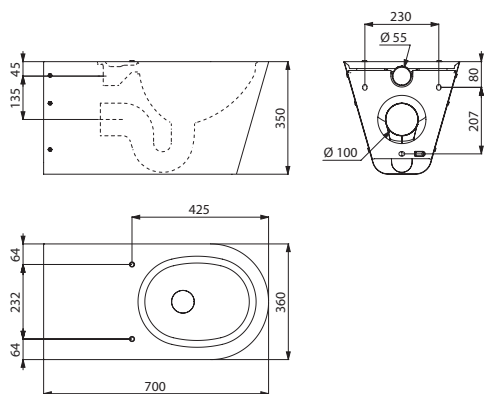

110710

Disabled WC - 700mm long - Polished satin 304 stainless steel	
Wall-hung disabled WC (700 S)	<b>110710</b>
Floor-standing disabled WC (700 P)	<b>110700</b>

**MONOBLOCO 700 PMR WC**



- Floor-standing WC pan with dual flush cistern 3L/6L.
- 700mm **elongated pan** for improved comfort for people with reduced mobility.
- **Bacteriostatic 304 stainless steel.**
- Stainless steel thickness: 1.5mm.
- One-piece pressed WC bowl, seam-free for better hygiene.
- WC bowl surface is polished with rounded edges for easy cleaning.
- Concealed perimetral flushing rim. Water supply can be recessed from below or exposed from the side (right/left).
- Recessed horizontal or vertical waste outlet. Supplied with PVC pipe.
- Pre-drilled holes for fixing the toilet seat. Supplied with stainless steel blanking caps when installed without toilet seat lid.
- Quick to install: 2 access panels with theft prevention TORX security screws.
- Weight: 22kg.
- 30-year warranty.
- CE marked. Complies with European standard EN 997 for 4L flush.

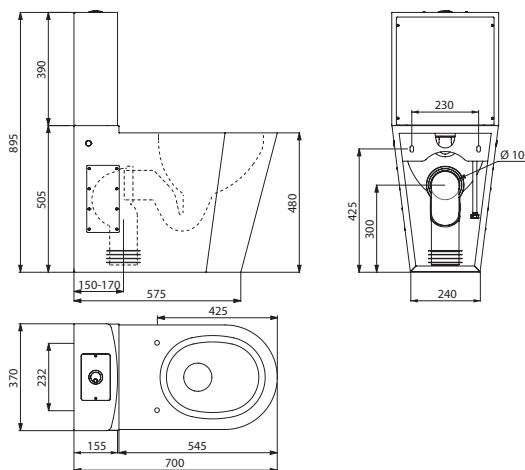

110790

Monobloco 700 PMR WC - Polished satin 304 stainless steel	
	<b>110790</b>



**PMR XS hand washbasin**

Wall-mounted



CE

- Wall-mounted hand washbasin **suitable for people with reduced mobility.**
- Basin internal diameter: 310mm.
- **Bacteriostatic 304 stainless steel.**
- Stainless steel thickness: 1.2mm.
- Rounded edges prevent injury.
- Supplied with 1¼" waste.
- Without overflow.
- Supplied with fixing elements.
- Weight: 3.9kg.
- 30-year warranty.
- CE marked. Complies with European standard EN 14688.

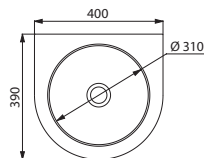
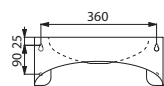
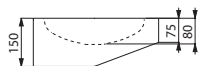

120400

**PMR XS hand washbasin**  
Polished satin 304 stainless steel

Without tap hole	<b>120400</b>
With right Ø 35mm tap hole	<b>123400</b>

**FRAJU PMR washbasin**

Wall-mounted



CE

- Wall-mounted washbasin, 620 × 505mm.
- **Suitable for people with reduced mobility.**
- **Bacteriostatic 304 stainless steel.**
- Stainless steel thickness: 1.2mm for the bowl and 1.5mm for the surround.
- Rounded edges prevent injury.
- Supplied with 1¼" waste.
- Without overflow.
- Supplied with fixing elements.
- Weight: 5 kg.
- 30-year warranty.
- CE marked. Complies with European standard EN 14688.

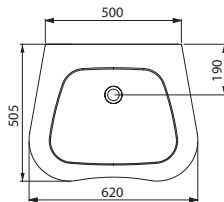
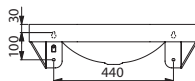

120440

**Wall-mounted FRAJU PMR washbasin**  
Polished satin 304 stainless steel

Without tap hole	<b>120440</b>
With central Ø 35mm tap hole	<b>121440</b>

**PMR shower tray**



CE

- Recessed shower tray.
- **Suitable for people with reduced mobility:** slimline shower tray.
- **Bacteriostatic 304 stainless steel.**
- Stainless steel thickness: 1.5mm.
- Depth: 30mm.
- Drainage slope.
- Supplied with 1½" waste.
- Non-slip surface.
- Weight of 800 × 800mm model: 8.5kg.  
Weight of 900 × 900mm model: 9.5kg.
- 30-year warranty.
- CE marked. Complies with European standard EN 14527.

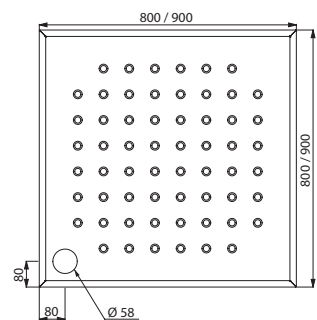

150500/150600

**Rec. shower tray for people with reduced mobility**

Polished satin 304 stainless steel 800 × 800mm	<b>150500</b>
Polished satin 304 stainless steel 900 × 900mm	<b>150600</b>



# Accessibility and Independence NylonClean Range

SHOWER SEATS  
**117**



GRAB BARS  
**121**



DROP-DOWN SUPPORT RAILS  
**123**

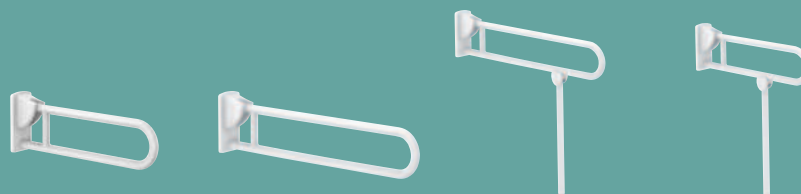

SHOWER GRAB BARS  
**124**



ACCESSORIES  
**132**

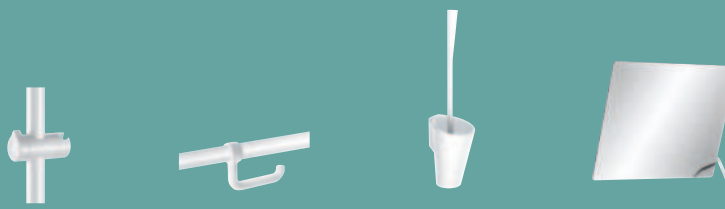



### MAXIMUM HYGIENE AND ERGONOMY

#### NylonClean anti-bacterial treatment

DELABIE's NylonClean grab bars and shower seats benefit from an anti-bacterial treatment.

This **protection against bacterial development and the appearance of mould**, alongside a regular cleaning protocol, provides hygiene and optimal defence against contamination spread by hand.

The active ingredient is integrated into the material during the manufacturing process. Therefore, the anti-bacterial property will not degrade and cannot be removed over time by UV radiation or even successive cleaning with chemicals.

DELABIE's NylonClean grab bars and shower seats are ideal for healthcare facilities, retirement homes and environments dedicated to the care of immunocompromised patients who are more vulnerable and particularly susceptible to contagion.

Anti-bacterial efficacy has been proven by an independent laboratory.

#### Bright HR Nylon

The Nylon used in the manufacture of DELABIE's grab bars is very high quality. The surface is perfectly uniform and non-porous for easy cleaning, ensuring the highest standards of hygiene. Compared to other synthetic materials it is highly resistant to abrasions, cracks and heat.

Nylon's technical properties are ideal for use in environments where hygiene is of the utmost importance e.g. hospitals, retirement homes, schools, etc.

#### Resistant to chemicals

DELABIE's NylonClean products will withstand the main cleaning products used in hospitals and commercial environments.

#### Seam-free straight sections

Particular attention has been paid to the design of DELABIE's NylonClean grab bars to reduce the number of joins and seams. This reduces the build-up of dirt, niches where bacteria can develop and the appearance of a black line, especially on the straight sections which are extruded in one-piece, and which have the most frequent contact with hands.

#### Smooth and warm to the touch

#### Optimised grip

The 32mm diameter of the grab bars ensures an optimum grip regardless of the end-use of the products. For healthcare facilities or public buildings we recommend grab bars with a diameter of 32mm.

### MAXIMUM SAFETY

#### Tested to over 200kg

In public and commercial places, the user weight is unknown. The products installed must therefore be able to support any user.

#### 30-year warranty

DELABIE's grab bars and shower seats are suitable for intensive use in all types of public or healthcare buildings.

Colour is added to the Nylon during manufacture ensuring a consistent colour throughout the bar. An anti-UV treatment prevents products from yellowing or ageing prematurely when exposed to strong light. DELABIE's NylonClean products remain in perfect condition throughout their lifespan.

#### CE marked

DELABIE's grab bars and shower seats are CE marked and conform to European Directive 93/42/CEE that relates to medical devices, and complies with European standard EN ISO 21856 "Technical aids". This provides an additional guarantee for product users.

#### Reinforced metal core

The 3.5mm Nylon casing is reinforced with a 2mm steel core that has been treated against corrosion. The core, along with the other elements, is made from highly resistant technical materials.

#### 38mm safety gap

The elderly or people with reduced mobility can easily lose their balance and fall. Limiting the gap between the bar and the wall to just 38mm prevents the forearm from getting trapped and significantly reduces the risk of fracture.

#### Space saving

Since they are closer to the wall, the grab bars require less space. This improves access within the sanitary facilities (showers, WCs, etc.) providing greater freedom of movement.

The grab bars are also more discreet.

#### Concealed fixings

All fixings (wall plate with 6 possible fixing points) are concealed by a Nylon cover plate.

### AND ALSO...

#### 100% interchangeable

The fixing plates for the bars are indexed and the dimensions are checked during the manufacturing process. There is no need to drill additional holes in the wall if replacing the bar with an identical one.

#### 100% recyclable

The bars are made from 100% recyclable materials, contributing to sustainable development and protecting the environment.

#### Complete range

Offering a wide range of products enables DELABIE to respond to the needs and requirements of the accessibility and independence sector. This offering complements DELABIE's other product ranges perfectly.

**TESTED TO OVER 200KG  
30-YEAR WARRANTY  
CE MARKED**

**38MM SAFETY GAP**  
Reduced risk of fracture  
Space saving

**3.5MM NYLON  
CASING**

**2MM REINFORCED  
METAL CORE**  
High resistance

**FIXINGS CONCEALED  
BY 1MM NYLON COVER  
PLATES**

**FIXING PLATES  
ARE INDEXED**  
100% interchangeable

**ANTI-BACTERIAL  
TREATMENT**

**Nylon  
Clean**

**BRIGHT HR  
NYLON**  
Easy to clean

**RESISTANT  
TO CHEMICALS**

**SEAM-FREE**  
No bacterial niches

**TUBE Ø 32MM**  
Optimised grip

**SMOOTH  
AND WARM  
TO TOUCH**

**100% RECYCLABLE**

ACCESSIBILITY  
NYLON CLEAN



Removable Comfort shower seat **510300N** - Two-wall corner grab bar with NylonClean sliding vertical riser rail **5481N**  
Thermostatic mixer **H9741TP** - Sliding shower head holder **510110** - Clip-on soap dish **510120N** - Shower head **813**

### Comfort removable shower seat

To hang on grab bars



### Additional products



Grab bars for shower seats  
(see pages 129 - 131)

- **HR Comfort shower seat and backrest.**
- **Large model.**
- To hang on grab bars  $\varnothing$  32mm  
(see ref.s 5481N, 5490N, 5121N and 50504N pages 129 - 131).
- **Anti-bacterial treatment** on seat and backrest: optimal protection against bacterial development.
- **Removable:** reduces the number of shower seats in a facility, allowing installation only when required.  
Example: hotels or hospitals providing short-term accommodation for people with reduced mobility.
- Suitable for intensive use in public places or the healthcare sector.
- Detachable solid seat made from high-strength polymer.
- Uniform non-porous surface for easy maintenance and hygiene.
- Good resistance to chemical products (Povidone-iodine) and cleaning.
- Anti-UV treatment.
- Warm to the touch.
- Bacteriostatic 304 stainless steel structure  $\varnothing$  32mm.
- **Adjustable screw jacks guarantee a good horizontal position.**
- **Large protective caps prevent damage to the wall.**
- Dimensions: 590 x 420 x 510mm.
- Tested to over 200kg. Maximum recommended user weight: 135kg.
- 30-year warranty.
- CE marked.

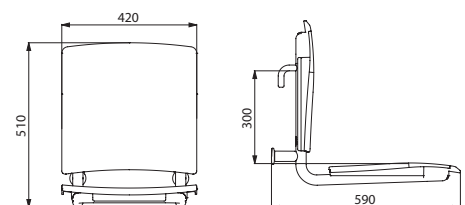

Removable Comfort shower seat to hang on grab bars  
White powder-coated stainless steel structure

510300N

510300N

**Lift-up shower seat**



- **HR Comfort shower seat and backrest.**
- **Large model.**
- **Anti-bacterial treatment** on seat and backrest: optimal protection against bacterial development.
- **Retained in upright position.**
- **Slowed down descent.**
- Suitable for intensive use in public places or the healthcare sector.
- Detachable solid seat made from high-strength polymer.
- Uniform non-porous surface for easy maintenance and hygiene.
- Good resistance to chemical products (Povidone-iodine) and cleaning.
- Anti-UV treatment.
- Warm to the touch.
- Bacteriostatic 304 stainless steel structure Ø 32mm.
- Concealed fixings, secured to wall by a 304 stainless steel plate, 4mm thick.
- Supplied with stainless steel screws for concrete walls.
- Seat dimensions: 506 × 420 × 138mm.
- Backrest dimensions: 56 × 420 × 410mm.
- Tested to over 200kg. Maximum recommended user weight: 135kg.
- 30-year warranty.
- CE marked.

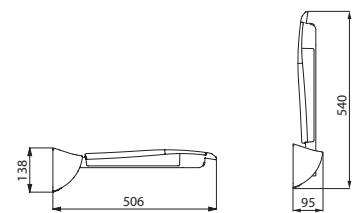

510420N

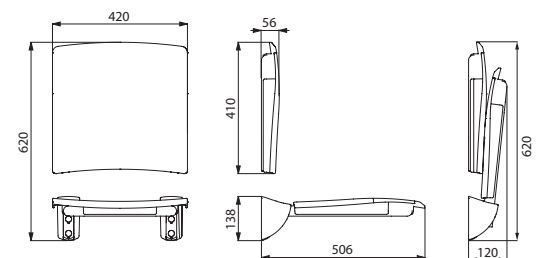

510420N+510429N

Lift-up Comfort shower seat - White powder-coated stainless steel structure	
Shower seat	<b>510420N</b>
Backrest	<b>510429N</b>



Lift-up shower seat with leg



- HR Comfort shower seat and backrest.
- Large model.
- Anti-bacterial treatment on seat and backrest: optimal protection against bacterial development.
- Retained in upright position.
- Slowed down descent.
- Suitable for intensive use in public places or the healthcare sector.
- Detachable solid seat made from high-strength polymer.
- Uniform non-porous surface for easy maintenance and hygiene.
- Good resistance to chemical products (Povidone-iodine) and cleaning.
- Anti-UV treatment.
- Warm to the touch.
- Bacteriostatic 304 stainless steel structure Ø 32mm.
- Reinforced by a folding, articulated leg made from 304 stainless steel tube Ø 25mm.
- Concealed fixings, secured to wall by a 304 stainless steel plate, 4mm thick.
- Supplied with stainless steel screws for concrete walls.
- Seat dimensions: 506 × 420 × 480mm.
- Backrest dimensions: 56 × 420 × 410mm.
- Tested to over 250kg. Maximum recommended user weight: 170kg.
- 30-year warranty.
- CE marked.

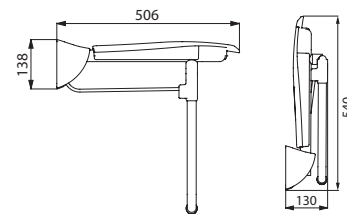

510430N

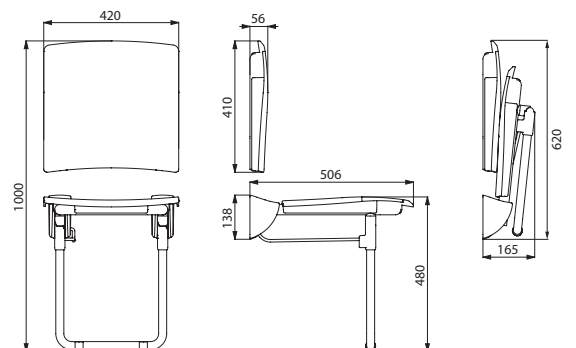

510430N+510429N

Lift-up Comfort shower seat with leg - White powder-coated stainless steel structure	
Shower seat with leg	510430N
Backrest	510429N



NylonClean angled grab bar 135° **5081N** - NylonClean drop-down support rail **5164N** - U-shaped toilet roll holder **4081N** - Toilet brush set with ergonomic handle **4051N**  
TEMPOFIX 3 frame system with TEMPOFLUX 3 time flow direct flush WC valve **564065+763000**

Angled grab bar 135°



- For WCs, showers or baths.
- For use as a handrail (horizontal part) or as a grab bar (135° part).
- NylonClean anti-bacterial treatment: optimal protection against bacterial development.
- Universal for either left or right side.
- Suitable for intensive use in public places or the healthcare sector.
- High-strength polyamide (Nylon): with 2mm reinforced steel core treated against corrosion.
- Uniform non-porous surface for easy maintenance and hygiene.
- Good resistance to chemical products and cleaning.
- Anti-UV treatment.
- Warm to the touch.
- 38mm gap between the bar and the wall: minimal space prevents the forearm passing between the bar and the wall, reducing the risk of fracture in case of loss of balance.
- 3 fixing points prevent the hand from getting trapped and simplify installation.
- Concealed fixings, secured to wall by a 6-hole plate, Ø 73mm.
- Supplied with stainless steel screws for concrete walls.
- Dimensions: 400 × 400mm or 220 × 220mm, Ø 32mm.
- Tested to over 200kg. Maximum recommended user weight: 135kg.
- 30-year warranty.
- CE marked.

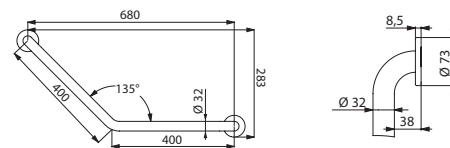

5081N

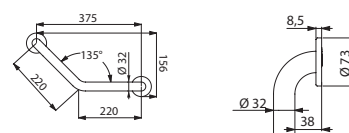

5083N

Angled grab bar 135°, Ø 32mm	
Bright white HR Nylon - 400 × 400 mm	<b>5081N</b>
Bright white HR Nylon - 220 × 220 mm	<b>5083N</b>

**Straight grab bar**

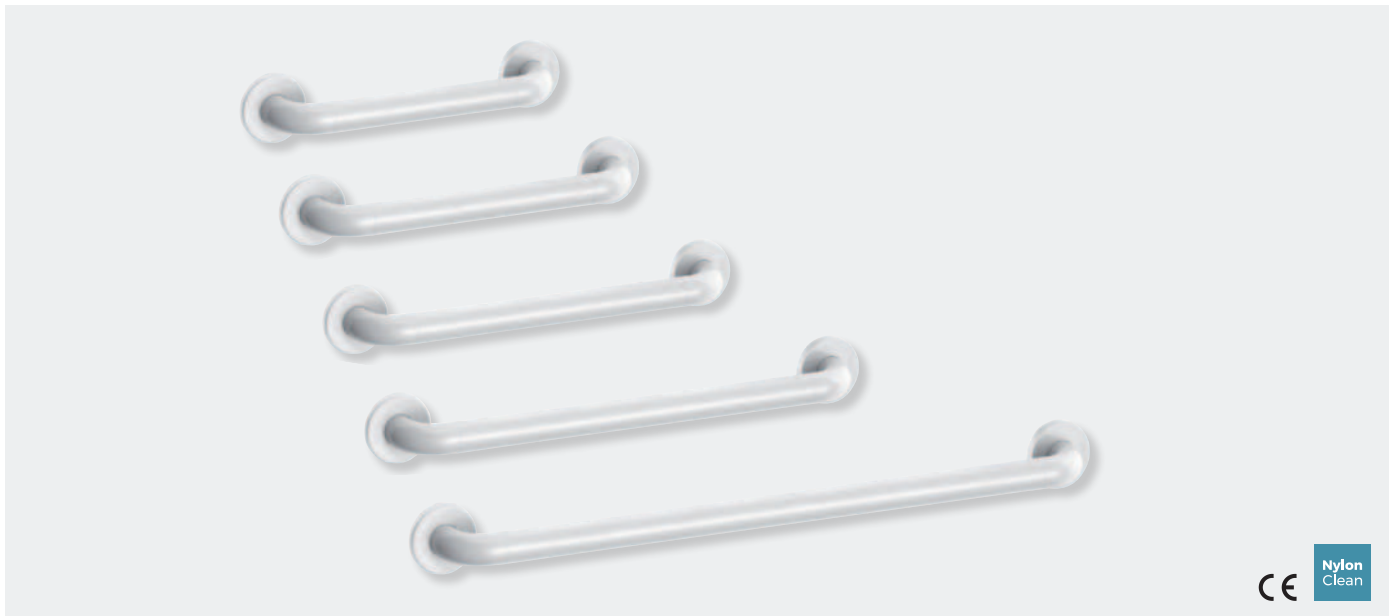

- For WCs, showers or baths.
- For use as a handrail, bar grab or support rail.
- **NylonClean anti-bacterial treatment:** optimal protection against bacterial development.
- Suitable for intensive use in public places or the healthcare sector.
- High-strength polyamide (Nylon):
  - with 2mm reinforced steel core treated against corrosion.
- Uniform non-porous surface for easy maintenance and hygiene.
- Good resistance to chemical products and cleaning.
- Anti-UV treatment.
- Warm to the touch.
- 38mm gap between the bar and the wall:
  - minimal space prevents the forearm passing between the bar and the wall, reducing the risk of fracture in case of loss of balance.
- Concealed fixings, secured to wall by a 6-hole plate, Ø 73mm.
- Supplied with stainless steel screws for concrete walls.
- Dimensions: 300 - 900mm centre-to-centre, Ø 32mm.
- Tested to over 200kg. Maximum recommended user weight: 135kg.
- 30-year warranty.
- CE marked.

Straight grab bar Ø 32mm	
Bright white HR Nylon - 300mm	<b>5050N</b>
Bright white HR Nylon - 400mm	<b>50504N</b>
Bright white HR Nylon - 500mm	<b>50505N</b>
Bright white HR Nylon - 600mm	<b>50506N</b>
Bright white HR Nylon - 900mm	<b>50509N</b>

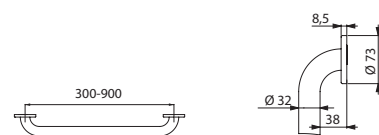

5050N/50504N/50505N/50506N/50509N

## Drop-down support rail



- For WCs or showers.
- Allows side access in the raised position.
- In the lowered position use as a grab bar, as a support for standing and for assisting movement.
- **NylonClean anti-bacterial treatment:** optimal protection against bacterial development.
- **Retained in upright position. Slowed down descent.**
- Suitable for intensive use in public places or the healthcare sector.
- High-strength polyamide (Nylon) and polymer: with 2mm reinforced steel core treated against corrosion.
- Uniform non-porous surface for easy maintenance and hygiene.
- Good resistance to chemical products and cleaning.
- Anti-UV treatment. Warm to the touch.
- Concealed fixings, secured to wall by a 304 stainless steel plate, 4mm thick.
- Supplied with stainless steel screws for concrete walls.
- Models with leg: **to be used as reinforcement when the wall fixing alone is insufficient.** Leg folds automatically. Leg height can be adjusted from 760 - 780mm. Dimensions: 850 or 650 × 800 × 105mm, Ø 32mm.
- Models without leg: 850 or 650 × 230 × 105mm, Ø 32mm.
- Tested to over 200kg. Maximum recommended user weight: 135kg.
- 30-year warranty. CE marked.

### Additional products



Backrest for WCs and toilet roll holder (see page 133)

### Related product



- Cover plate**
- Conceals the fixing screws when the drop-down support rail is removed.
  - Reduces the number of rails in a facility, allowing installation only when required.
  - Supplied with stainless steel screws for concrete walls.
  - 30-year warranty.

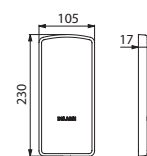

510150N

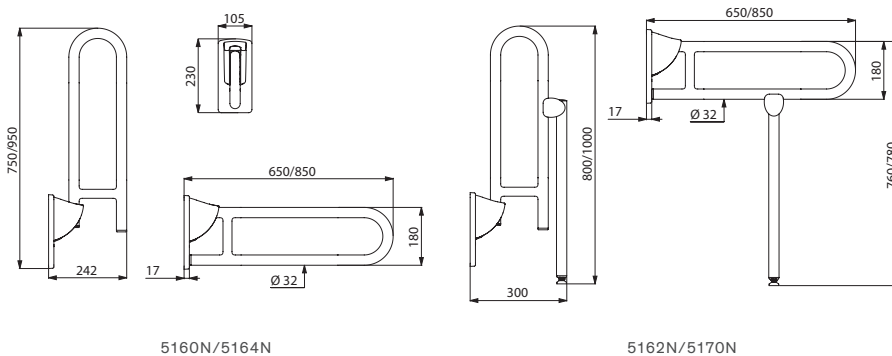

5160N/5164N

5162N/5170N

Drop-down support rail with concealed fixings Ø 32mm without leg	
Bright white HR Nylon - L. 650mm	<b>5160N</b>
Bright white HR Nylon - L. 850mm	<b>5164N</b>
Drop-down support rail with concealed fixings Ø 32mm with leg	
Bright white HR Nylon - L. 650mm	<b>5162N</b>
Bright white HR Nylon - L. 850mm	<b>5170N</b>

Nylon cover with fixing plate	<b>510150N</b>
-------------------------------	----------------

**Straight bar with sliding shower head holder**



**Additional products**



Sliding soap dish and shower head  
(see page 132)

- For showers or baths.
- Can be used as a vertical grab bar and a shower head riser rail.
- HR Nylon sliding shower head holder with ergonomic locking ring.
- Sliding soap dish can be added (order separately).
- NylonClean anti-bacterial treatment: optimal protection against bacterial development.
- Suitable for intensive use in public places or the healthcare sector.
- High-strength polyamide (Nylon):  
with 2mm reinforced steel core treated against corrosion.
- Uniform non-porous surface for easy maintenance and hygiene.
- Good resistance to chemical products and cleaning.
- Anti-UV treatment.
- Warm to the touch.
- 38mm gap between the bar and the wall:  
minimal space prevents the forearm passing between the bar and the wall, reducing the risk of fracture in case of loss of balance.
- Concealed fixings, secured to wall by a 6-hole plate, Ø 73mm.
- Supplied with stainless steel screws for concrete walls.
- Height: 1,150mm, Ø 32mm.
- Tested to over 200kg. Maximum recommended user weight: 135kg.
- 30-year warranty.
- CE marked.

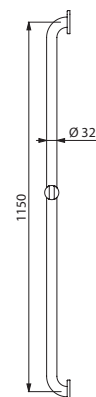
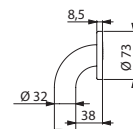

<p><b>Straight bar Ø 32mm with sliding shower head holder</b> Bright white HR Nylon H. 1,150mm</p>	<p><b>5460N</b></p>
--	---------------------

5460N

## Right angled grab bar and angled riser rail



- For showers.
- Use as a grab bar and to support the user in an upright position.
- Helps and secures entry and movement in the shower.
- Use as a shower rail by adding a sliding shower head holder and/or soap dish.
- NylonClean anti-bacterial treatment: optimal protection against bacterial development.
- Can be installed with the upright to the left or right side.
- Suitable for intensive use in public places or the healthcare sector.
- High-strength polyamide (Nylon): with 2mm reinforced steel core treated against corrosion.
- Uniform non-porous surface for easy maintenance and hygiene.
- Good resistance to chemical products and cleaning.
- Anti-UV treatment.
- Warm to the touch.
- 38mm gap between the bar and the wall: minimal space prevents the forearm passing between the bar and the wall, reducing the risk of fracture in case of loss of balance.
- Concealed fixings, secured to wall by a 6-hole plate, Ø 73mm.
- Supplied with stainless steel screws for concrete walls.
- Dimensions: 1,245 × 570 × 660mm, Ø 32mm.
- Tested to over 200kg. Maximum recommended user weight: 135kg.
- 30-year warranty.
- CE marked.

## Additional products



Sliding shower head holder, sliding soap dish, shower head and shower shelf with glove holder (see pages 132 & 133)

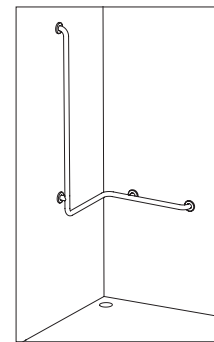

Installation example for showers

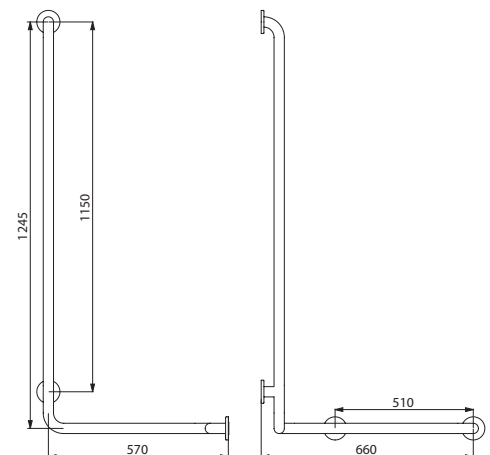
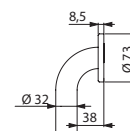

Right angled grab bar and angled riser rail Ø 32mm - Bright white HR Nylon

5100N

5100N



Lift-up Comfort shower seat **510420N+510429N** - SECURITHERM BIOSAFE thermostatic shower mixer **H9769** - NylonClean L-shaped grab bar **5071N**  
Sliding shower head holder **510110** - Soap dish **510120N** - Coat hooks **4043N**



## L-shaped grab bar



### Additional products



Sliding shower head holder, sliding soap dish, shower head and shower shelf with glove holder (see pages 132 & 133)

- For showers or baths.
- Helps the user stand and move safely in the shower or bath.
- Use as a shower rail by adding a sliding shower head holder and/or soap dish.
- **NylonClean anti-bacterial treatment:** optimal protection against bacterial development.
- Can be installed with the upright to the left or right side.
- Suitable for intensive use in public places or the healthcare sector.
- High-strength polyamide (Nylon): with 2mm reinforced steel core treated against corrosion.
- Uniform non-porous surface for easy maintenance and hygiene.
- Good resistance to chemical products and cleaning.
- Anti-UV treatment.
- Warm to the touch.
- 38mm gap between the bar and the wall: minimal space prevents the forearm passing between the bar and the wall, reducing the risk of fracture in case of loss of balance.
- Concealed fixings, secured to wall by a 6-hole plate, Ø 73mm.
- Supplied with stainless steel screws for concrete walls.
- Dimensions: 1,245 or 750 × 450mm, Ø 32mm.
- Tested to over 200kg. Maximum recommended user weight: 135kg.
- 30-year warranty.
- CE marked.

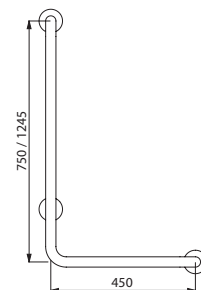
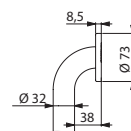

5070N/5071N

L-shaped grab bar Ø 32mm	
Bright white HR Nylon - H. 750mm	<b>5070N</b>
Bright white HR Nylon - H. 1,245mm	<b>5071N</b>

T-shaped grab bar



Additional products



Sliding shower head holder, sliding soap dish, shower head and shower shelf with glove holder (see pages 132 & 133)

- For showers.
- Use as a grab bar and to support the user in an upright position.
- Helps and secures entry and movement in the shower.
- Use as a shower riser rail by adding a sliding shower head holder and/or soap dish.
- **NylonClean anti-bacterial treatment:** optimal protection against bacterial development.
- Model with sliding riser rail: **upright position can be adjusted during installation.** Can be moved to the left or the right in order to adapt the space (positioning of shower, depth of shower seat...).
- Suitable for intensive use in public places or the healthcare sector.
- High-strength polyamide (Nylon): with 2mm reinforced steel core treated against corrosion.
- Uniform non-porous surface for easy maintenance and hygiene.
- Good resistance to chemical products and cleaning.
- Anti-UV treatment.
- Warm to the touch.
- 38mm gap between the bar and the wall: minimal space prevents the forearm passing between the bar and the wall, reducing the risk of fracture in case of loss of balance.
- Concealed fixings, secured to wall by a 6-hole plate, Ø 73mm.
- Supplied with stainless steel screws for concrete walls.
- Dimensions: 1,150 × 500mm, Ø 32mm.
- Tested to over 200kg. Maximum recommended user weight: 135kg.
- 30-year warranty.
- CE marked.

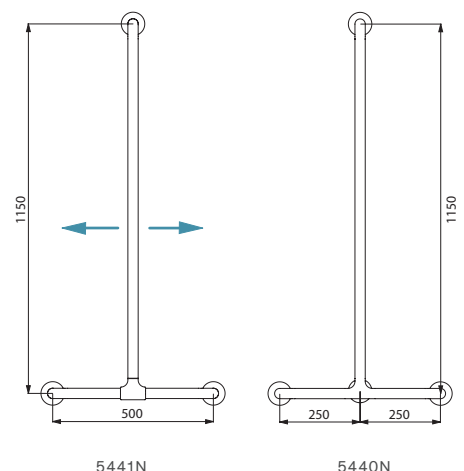
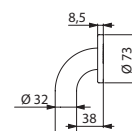
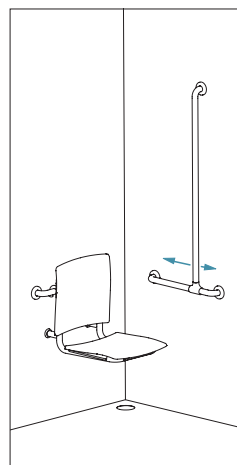

T-shaped grab bar Ø 32mm - Bright white HR Nylon	
With sliding riser rail	5441N
With fixed riser rail	5440N

### Two-wall grab bar with vertical riser rail

For shower seats



### Additional products

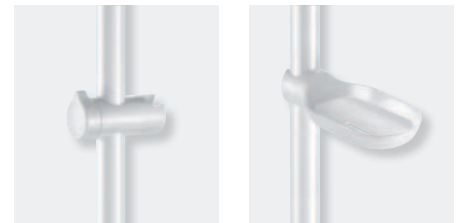

Removable shower seat (see page 117), sliding shower head holder, sliding soap dish and shower shelf with glove holder (see pages 132 & 133)

- For showers.
- Can support a removable shower seat (order separately).
- Use as a grab bar and to support the user in an upright position.
- Helps and secures entry and movement in the shower.
- Use as a shower riser rail by adding a sliding shower head holder and/or soap dish.
- NylonClean anti-bacterial treatment: optimal protection against bacterial development.
- Model with sliding riser rail: **upright position can be adjusted during installation.** Can be moved to the left or the right in order to adapt the space (positioning of shower, depth of shower seat...).
- Can be installed with the upright on the left or the right.
- Suitable for intensive use in public places or the healthcare sector.
- High-strength polyamide (Nylon): with 2mm reinforced steel core treated against corrosion.
- Uniform non-porous surface for easy maintenance and hygiene.
- Good resistance to chemical products and cleaning.
- Anti-UV treatment. Warm to the touch.
- 38mm gap between the bar and the wall: minimal space prevents the forearm passing between the bar and the wall, reducing the risk of fracture in case of loss of balance.
- Concealed fixings, secured to wall by a 6-hole plate, Ø 73mm.
- Supplied with stainless steel screws for concrete walls.
- Dimensions: 1,150 × 750 × 750mm, Ø 32mm.
- Tested to over 200kg. Maximum recommended user weight: 135kg.
- 30-year warranty.
- CE marked.

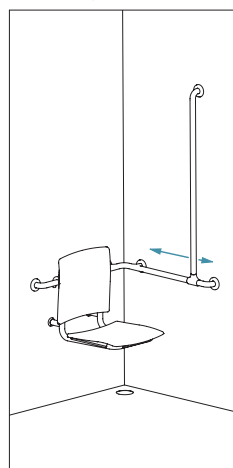

Upright can be adjusted left or right (Ref. 5481N)

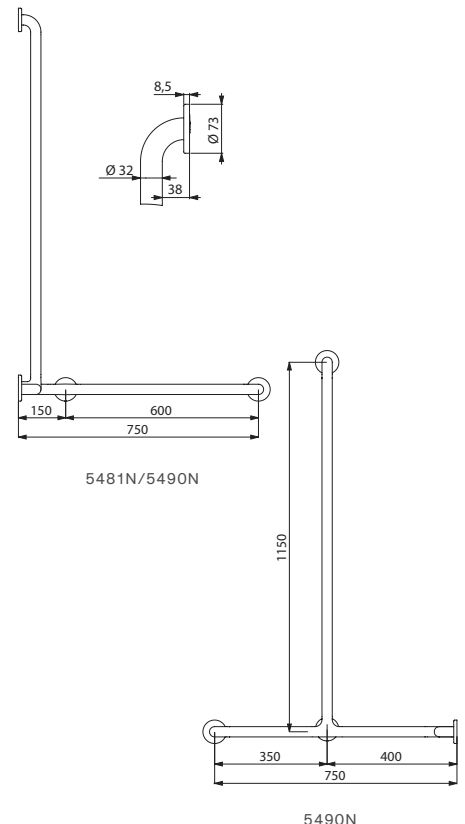

Two-wall grab bar Ø 32mm - Bright white HR Nylon - For shower seats	
With sliding riser rail	5481N
With fixed riser rail	5490N

ACCESSIBILITY  
NYLON CLEAN

**Two-wall corner grab bar**

For shower seats



- For WCs, showers or baths.
- Can support a removable shower seat (order separately).
- Use as a grab bar and to support the user in an upright position.
- Helps and secures entry and movement in the shower or bath.
- Helps with the transfer from a wheelchair to the toilet seat for WCs with recessed cisterns or direct flush.
- **NylonClean anti-bacterial treatment:** optimal protection against bacterial development.
- Suitable for intensive use in public places or the healthcare sector.
- High-strength polyamide (Nylon):
  - with 2mm reinforced steel core treated against corrosion.
- Uniform non-porous surface for easy maintenance and hygiene.
- Good resistance to chemical products and cleaning.
- Anti-UV treatment.
- Warm to the touch.
- 38mm gap between the bar and the wall:
  - minimal space prevents the forearm passing between the bar and the wall, reducing the risk of fracture in case of loss of balance.
- Concealed fixings, secured to wall by a 6-hole plate, Ø 73mm.
- Supplied with stainless steel screws for concrete walls.
- Dimensions: 750 × 750mm, Ø 32mm.
- Tested to over 200kg. Maximum recommended user weight: 135kg.
- 30-year warranty.
- CE marked.

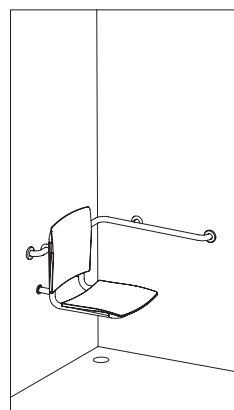

Installation example for showers

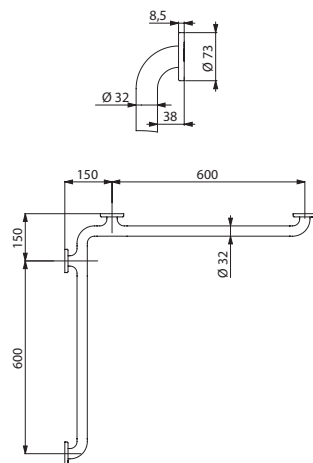

5121N

**Additional products**

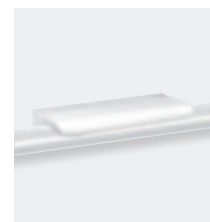

Removable shower seat ([see page 117](#)) and shower shelf with glove holder ([see page 133](#))

**Single grab bar**

For shower seats



CE 

- For showers.
- Can support a removable shower seat (order separately).
- Use as a grab bar and to support the user in an upright position.
- Helps and secures entry and movement in the shower.
- **NylonClean anti-bacterial treatment:** optimal protection against bacterial development.
- Suitable for intensive use in public places or the healthcare sector.
- High-strength polyamide (Nylon):  
with 2mm reinforced steel core treated against corrosion.
- Uniform non-porous surface for easy maintenance and hygiene.
- Good resistance to chemical products and cleaning.
- Anti-UV treatment.
- Warm to the touch.
- 38mm gap between the bar and the wall:  
minimal space prevents the forearm passing between the bar and the wall,  
reducing the risk of fracture in case of loss of balance.
- Concealed fixings, secured to wall by a 6-hole plate,  $\varnothing$  73mm.
- Supplied with stainless steel screws for concrete walls.
- Dimensions: 400mm,  $\varnothing$  32mm.
- Tested to over 200kg. Maximum recommended user weight: 135kg.
- 30-year warranty.
- CE marked.

**Additional product**

CE 

Removable shower seat (see page 117)

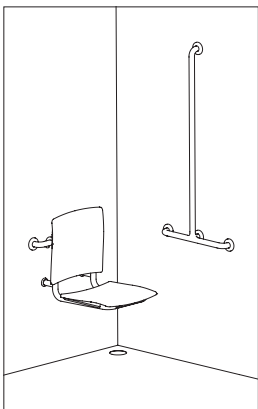
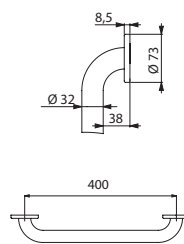
Installation example  
for showers

50504N

**Sliding shower head holder**



- High-strength polyamide (Nylon).
- Support for adjustable shower heads.
- Ergonomic locking ring.
- **For Ø 32mm grab bars.**
- 30-year warranty.

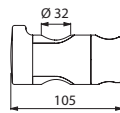

510110

Sliding shower head holder - Bright white HR Nylon 510110

**Clip-on sliding soap dish**



- High-strength polyamide (Nylon).
- Soap dish for shower gel or soap.
- **For Ø 25 and Ø 32mm grab bars.**
- 30-year warranty.

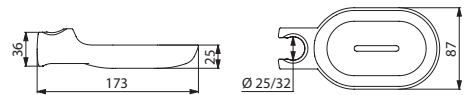

510120N

Clip-on soap dish - Bright white HR Nylon 510120N

**Shower head**



- M $\frac{1}{2}$ " shower head in chrome-plated ABS.
- Monojet: rain effect.
- Manual system for removing limescale.
- 30-year warranty.

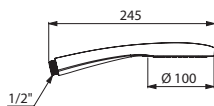

815

Rain effect shower head 815

**Shower head retaining collar**



- For Ø 25 - 35mm rails and flexible shower hose.
- **Retaining device:** prevents shower head from coming into direct contact with the floor or floor trap (source of bacterial contamination).
- 30-year warranty.

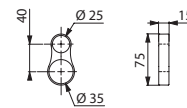

830

Translucent shower head retaining collar 830

### Shower shelf for grab bars

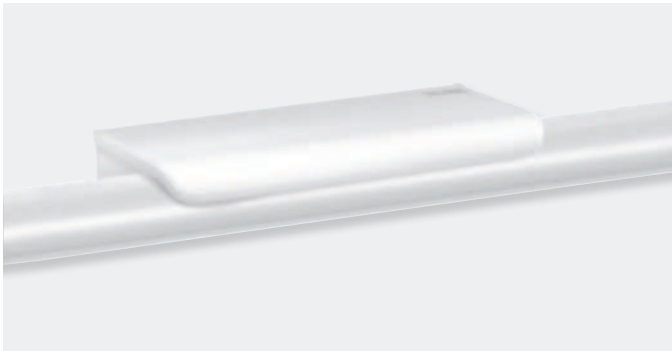

- Place against the wall, on the grab bar.
- **Anti-theft lock.**
- Suitable for shower gel or soap.
- **2 hooks for gloves.**
- 30-year warranty.

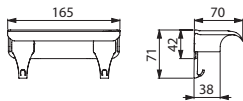

511922W

Shower shelf for grab bars - White

511922W

### Toilet roll holder for grab bars

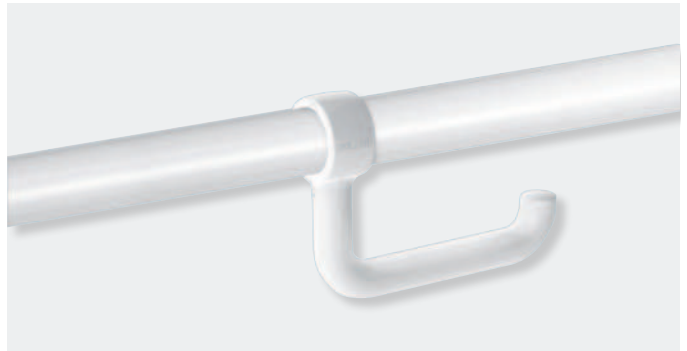

- For toilet rolls.
- High-strength polyamide (Nylon).
- Can be fitted without removing the grab bar.
- Anti-theft lock.
- Anti-rotating locking feature.
- **For Ø 32 - 34mm grab bars.**
- 30-year warranty.

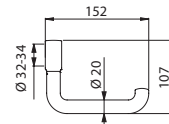

510081N

Toilet roll holder for grab bars - Bright white HR Nylon

510081N

### Comfort backrest for WCs



- Backrest made from soft polyurethane.
- High-strength polyamide (Nylon) tube, Ø 32mm.
- Concealed fixings, secured to wall by a 6-hole plate, Ø 73mm.
- Dimensions: 150 × 575 × 173mm.
- CE marked.
- 30-year warranty.

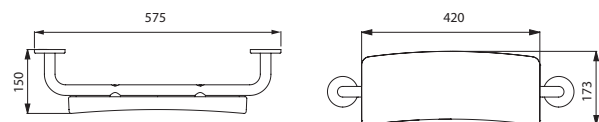

510629N

Comfort backrest for WCs - Bright white HR Nylon

510629N

**Toilet brush set**

With anti-theft lock and **long handle**



- High-strength polyamide (Nylon).
- **Long, ergonomic handle:** easy for wheelchair users or people who have difficulty bending to use.
- Easy to clean: plastic bowl can be removed from above.
- **Plastic bowl with reservoir:** prevents toilet brush sitting in residual water and reduces the risk of splashing when next used.
- Wall-mounted with **anti-theft lock**.
- Height: 515mm.
- 30-year warranty.

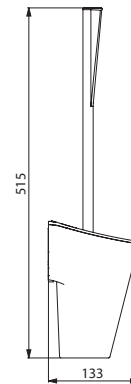

4051N

Toilet brush set bright white HR Nylon with long handle - Anti-theft lock

4051N

**Spare toilet roll holder**



- High-strength polyamide (Nylon).
- Tube Ø 32mm.
- **Concealed fixings.**
- 30-year warranty.

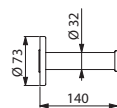

4070N

Spare toilet roll holder - Bright white HR Nylon

4070N

**U-shaped toilet roll holder**

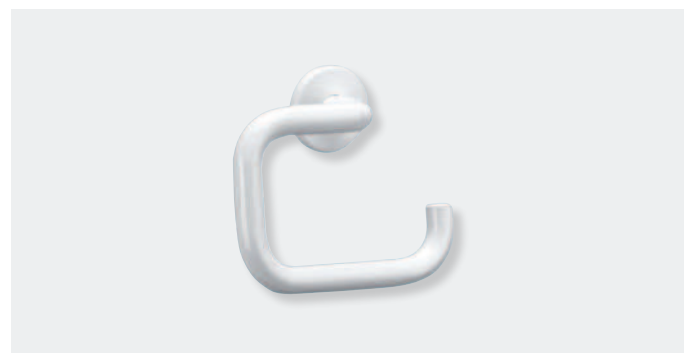

- High-strength polyamide (Nylon).
- Tube Ø 20mm.
- **Concealed fixings.**
- 30-year warranty.

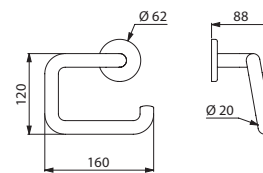

4081N

U-shaped toilet roll holder - Bright white HR Nylon

4081N



### Coat hook



- High-strength polyamide (Nylon).
- Tube Ø 20mm.
- **Concealed fixings.**
- 30-year warranty.

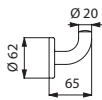

4043N

Coat hook - Bright white HR Nylon 4043N

### Double coat hook



- White powder-coated 304 stainless steel.
- Tube Ø 20mm, 1mm thick.
- **Concealed fixings.**
- 30-year warranty.

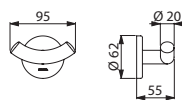

4042W

Double coat hook - White powder-coated 304 stainless steel 4042W

### Coat hook

Single or double

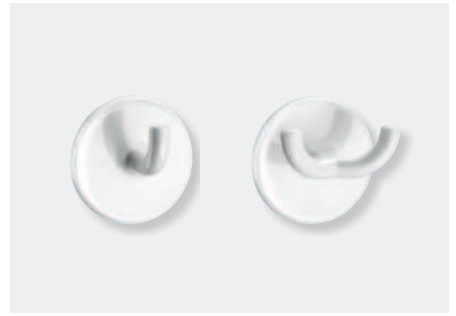

- High-strength polyamide (Nylon).
- Tube Ø 10mm.
- **Concealed fixings.**
- 30-year warranty.



510043N

510042N

#### Coat hook - Bright white HR Nylon

Model single	510043N
Model double	510042N

### MINERALCAST PMR washbasin



Wall-mounted MINERALCAST PMR washbasin with central tap hole Ø 35mm

132306

- Wall-mounted washbasin, 785 × 545 × 170mm.
- **With integral side grips** which can be used as a support or a towel holder.
- MINERALCAST: composite material consisting of natural minerals and polyester resin.
- **Shallow washbasin suitable for wheelchair users and use from a sitting position.**
- Uniform non-porous surface is easy to clean.
- One-piece cast washbasin, seam-free, for easy maintenance and better hygiene.
- Warm to the touch.
- Without overflow.
- Supplied with fixing elements.
- Weight: 21.5kg.
- 30-year warranty.
- CE marked. Complies with European standard EN 14688.

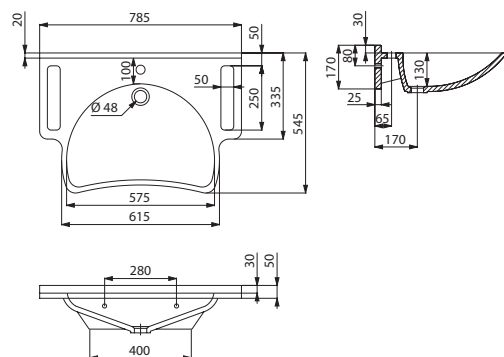

132306



### Tilting mirror with long, ergonomic lever



- **For combined installation:** can be used from sitting or standing position.
- **Long, ergonomic lever for easy adjustment of mirror angle from a sitting position or from a wheelchair.**
- Lever with anti-bacterial treatment: optimal protection against bacterial development.
- **Quick and easy to install:** simply clip into place.
- **Anti-theft lock.**
- Bright white HR Nylon lever.
- Mirror made from 6mm laminated safety glass.
- Can be tilted up to 20°.
- Mirror dimensions: 500 × 600mm.
- 30-year warranty.

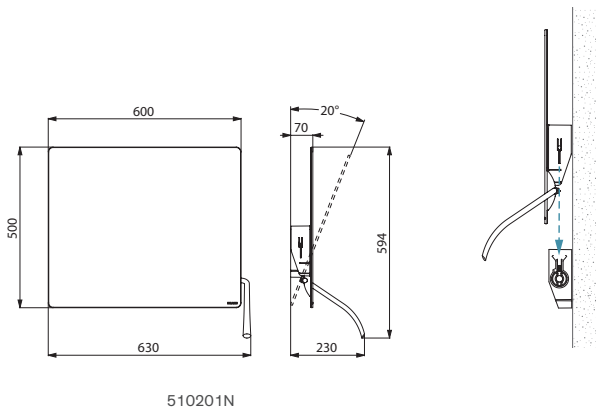

**Tilting mirror with long, ergonomic - white HR Nylon lever**      **510201N**  
 For more mirrors and studded pegs see pages 43 - 45.

### Tilting mirror with tab handle



- **For combined installation:** can be used from sitting or standing position.
- **Tab handle for easy adjustment of mirror angle for those in a sitting position or for wheelchair users.**
- Handle with anti-bacterial treatment: optimal protection against bacterial development.
- **Quick and easy to install:** simply clip into place.
- **Anti-theft lock.**
- Bright white HR Nylon handle.
- Mirror made from 6mm laminated safety glass.
- Can be tilted up to 20°.
- Mirror dimensions: 500 × 600mm.
- 30-year warranty.

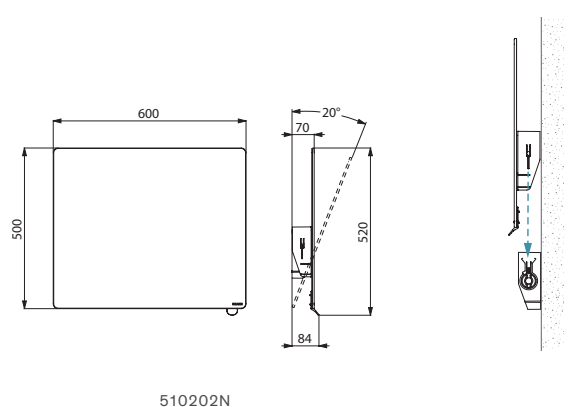

**Tilting mirror with white HR Nylon tab handle**      **510202N**  
 For more mirrors and studded pegs see pages 43 - 45.

ACCESSIBILITY  
 NYLON CLEAN



DELABIE

# Accessibility and Independence

## Basic and ECO Ranges

SHOWER SEATS  
& STOOL  
**141**



WHITE  
BASIC  
GRAB BARS  
**144**

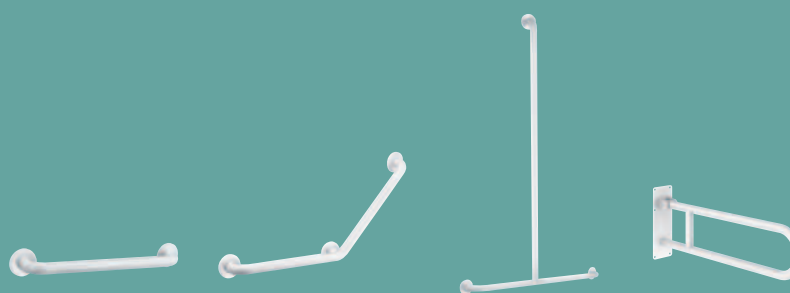

SATIN FINISH  
BASIC  
GRAB BARS  
**147**



ECO  
GRAB BARS  
**148**





**BASIC + lift-up shower seat with leg**



- **Lift-up:** retained in upright position and slowed down descent.
- **Non-slip solid seat** made from high strength polymer.
- Removable seat, easy to maintain and comfortable.
- Hinged leg which folds automatically.
- Structure made from white aluminium tubing,  $\varnothing 25 \times 2$ mm.
- **Concealed fixings.**
- Dimensions:  $410 \times 360 \times 480$ mm.
- Folded dimensions:  $85 \times 562$ mm.
- Seat height: 480 mm.
- Tested to over 200kg. Maximum recommended user weight: 135kg.
- 30-year warranty.
- CE marked.

ACCESSIBILITY  
BASIC - ECO

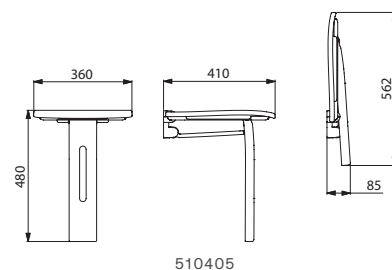

BASIC + lift-up shower seat with leg	510405
--------------------------------------	--------



ALU lift-up shower seat **510400** - Angled grab bar 135° **35082W** - SECURITHERM time flow thermostatic shower panel **792320**



**ALU lift-up shower seat with leg**



- **Lift-up:** retained in upright position and slowed down descent.
- **Large plastic slats are comfortable and easy to maintain.**
- Folding leg guided by an articulated arm.
- Structure made from white aluminium tube  $\varnothing 25 \times 2\text{mm}$ .
- **Concealed fixings.**
- **Large model:**  $430 \times 465 \times 480\text{mm}$ . Folded dimensions:  $82 \times 565\text{mm}$ . Leg height can be adjusted up to 8mm.
- **Ergonomic non-slip side grips.**
- **Standard model:**  $407 \times 360 \times 480\text{mm}$ . Folded dimensions:  $82 \times 545\text{mm}$ .
- Seat height: 480mm.
- Supplied with stainless steel screws for concrete walls.
- Tested to over 200kg.
- Maximum recommended user weight: 135kg.
- 30-year warranty.
- CE marked.

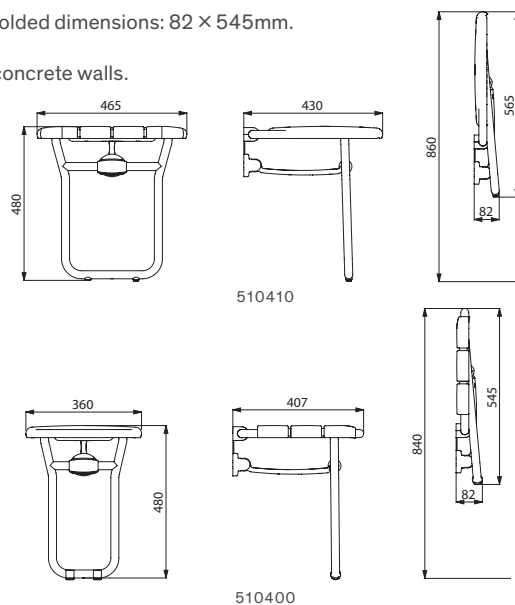

<b>ALU lift-up shower seat with leg</b>	
Large model	<b>510410</b>
Standard model	<b>510400</b>

**ALU shower stool**



- **Large plastic slats are comfortable and easy to maintain.**
- Structure made from white aluminium tube  $\varnothing 25 \times 2\text{mm}$ .
- Dimensions:  $400 \times 360 \times 480\text{mm}$ .
- Seat height: 480mm.
- Tested to over 200kg.
- Maximum recommended user weight: 135kg.
- Legs with plastic protective feet.
- 30-year warranty.

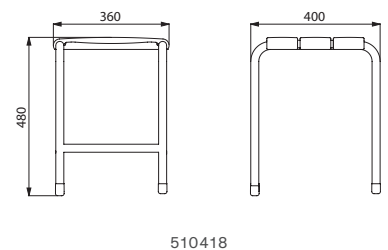

<b>ALU shower stool</b>	
	<b>510418</b>

ACCESSIBILITY  
BASIC - ECO

**White powder-coated Basic straight grab bar**

Tube Ø 32mm



- White powder-coated stainless steel.
- Concealed fixings, secured to wall by a 3-hole plate.
- 30-year warranty.
- CE marked.

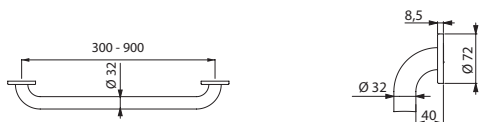

35050W/350504W/350505W/350506W

Basic straight grab bar Ø 32mm	
White powder-coated stainless steel - 300mm	<b>35050W</b>
White powder-coated stainless steel - 400mm	<b>350504W</b>
White powder-coated stainless steel - 500mm	<b>350505W</b>
White powder-coated stainless steel - 600mm	<b>350506W</b>

**White powder-coated Basic angled grab bar 135°**

Tube Ø 32mm



- White powder-coated stainless steel.
- **3 fixing points prevent the hand from getting trapped and simplify installation.**
- Concealed fixings, secured to wall by a 3-hole plate.
- Dimensions: 400 × 400mm.
- 30-year warranty.
- CE marked.

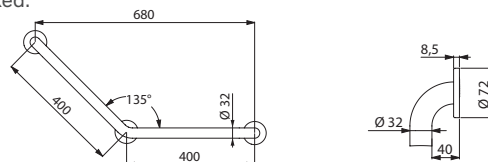

35082W

Basic angled grab bar 135° Ø 32mm White powder-coated stainless steel	<b>35082W</b>
--	---------------

**White powder-coated Basic T-shaped grab bar**

Tube Ø 32mm



- White powder-coated stainless steel.
- Concealed fixings, secured to wall by a 3-hole plate.
- Dimensions: 1,150 × 500mm.
- 30-year warranty.
- CE marked.

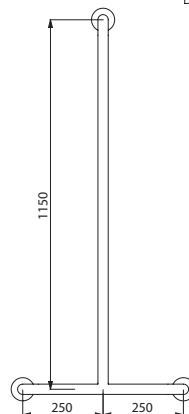
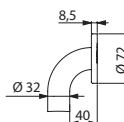

35440W

Basic T-shaped grab bar Ø 32mm White powder-coated stainless steel	<b>35440W</b>
---	---------------



Sliding shower head holder and sliding soap dish  
(see opposite)

**White powder-coated Basic two-wall grab bar with sliding vertical riser rail**

Tube Ø 32mm



- White powder-coated stainless steel.
- **Upright position can be adjusted during installation:** can be moved to the left or the right.
- Can be installed with the upright on the left or the right.
- Concealed fixings, secured to wall by a 3-hole plate.
- Dimensions: 1,150 × 750 × 750mm.
- 30-year warranty.
- CE marked.

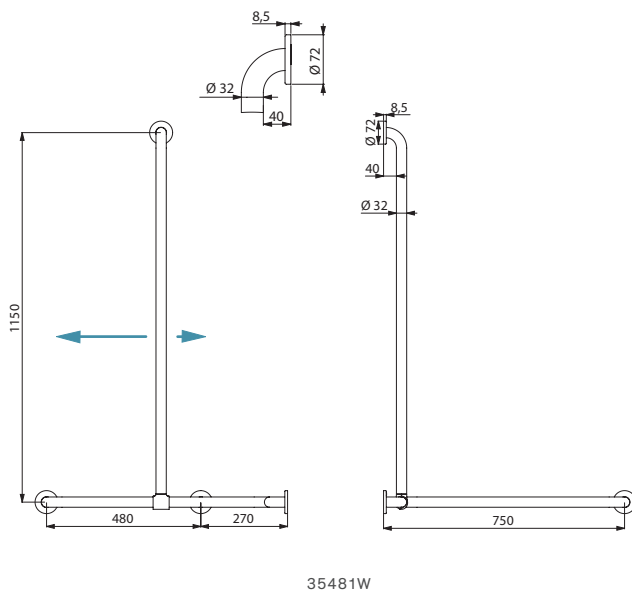

35481W

Basic two-wall grab bar with sliding vertical riser rail Ø 32mm  
White powder-coated stainless steel

35481W

**Related products**

**Sliding shower head holder**



- High-strength polyamide (Nylon).
- Support for adjustable shower heads.
- Ergonomic locking ring.
- **For Ø 32mm rails.**
- 30-year warranty.

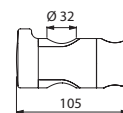

510110

Sliding holder  
Bright white HR Nylon

510110

**Clip-on sliding soap dish**



- High-strength polyamide (Nylon).
- Soap dish for shower gel or soap.
- **For Ø 25 and Ø 32mm rails.**
- 30-year warranty.

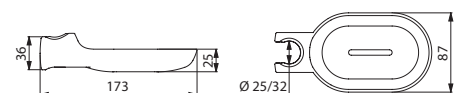

510120N

Clip-on soap dish  
Bright white HR Nylon

510120N

**White powder-coated Basic drop-down support rail**

Tube Ø 32mm

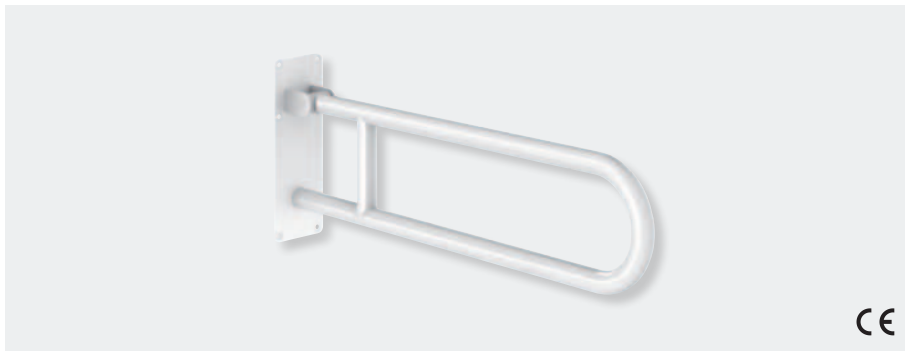

- White powder-coated stainless steel.
- Visible fixings, secured to wall by a 6-hole plate.
- Dimensions: 760 × 300 × 100mm.
- **Wall plate thickness: 3.5mm.**
- 30-year warranty.
- CE marked.

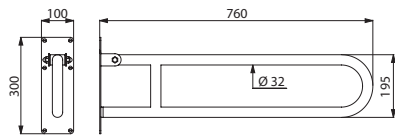

511516W

Basic drop-down support rail Ø 32mm - White powder-coated stainless steel 511516W

**Related product**

**Toilet roll holder for grab bars**

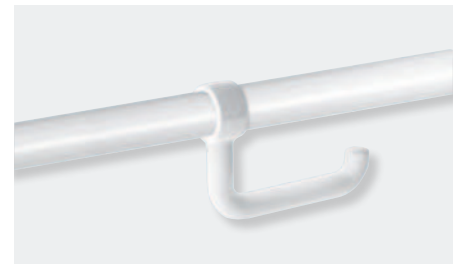

- For toilet rolls.
- High-strength polyamide (Nylon).
- Can be fitted without removing the grab bar.
- Anti-theft lock.
- Anti-rotating locking feature.
- **For Ø 32 - Ø 34mm bars.**
- 30-year warranty.

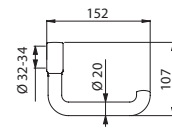

510081N

Toilet roll holder for grab bars Bright white HR Nylon 510081N

**White powder-coated Basic drop-down support rail**

Tube Ø 32mm, with leg



- White powder-coated stainless steel.
- Visible fixings, secured to wall by a 6-hole plate.
- With automatic folding leg.
- To be used as a reinforcement when the wall fixing alone is insufficient.
- Dimensions: 760 × 815 × 100mm.
- Adjustable leg height from 760 to 780mm.
- **Wall plate thickness: 3.5mm.**
- 30-year warranty.
- CE marked.



Toilet roll holder (see above)

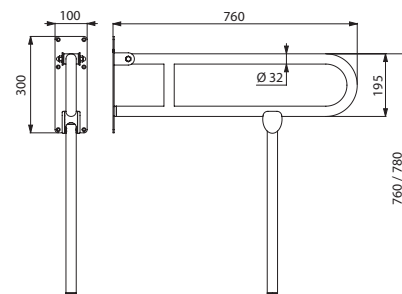

511517W

Basic drop-down support rail Ø 32mm with leg White powder-coated stainless steel 511517W

### Satin finish Basic straight grab bar

Tube Ø 32mm



- Polished satin 304 stainless steel.
- Concealed fixings, secured to wall by a 3-hole plate.
- 30-year warranty.
- CE marked.



35050S/350504S/350505S/350506S/350508S/350509S

Basic straight grab bar Ø 32mm	
Polished satin 304 stainless steel - 300mm	35050S
Polished satin 304 stainless steel - 400mm	350504S
Polished satin 304 stainless steel - 500mm	350505S
Polished satin 304 stainless steel - 600mm	350506S
Polished satin 304 stainless steel - 800mm	350508S
Polished satin 304 stainless steel - 900mm	350509S

### Satin finish Basic angled grab bar 135°

Tube Ø 32mm



- Polished satin 304 stainless steel.
- 3 fixing points prevent the hand from getting trapped and simplify installation.
- Concealed fixings, secured to wall by a 3-hole plate.
- Dimensions: 400 × 400mm.
- 30-year warranty.
- CE marked.

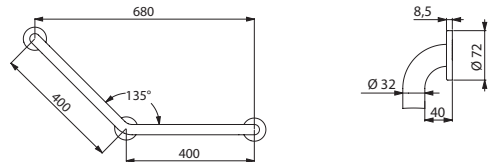

35082S

Basic angled grab bar 135° Ø 32mm Polished satin 304 stainless steel	35082S
---	--------

### Satin finish Basic drop-down support rail

Tube Ø 32mm

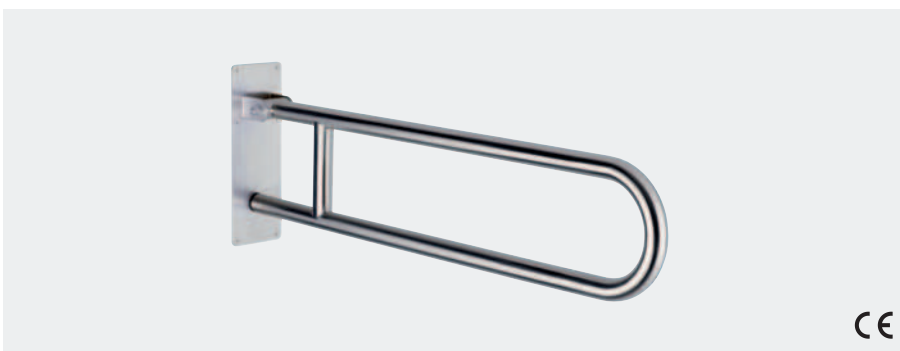

- Polished satin 304 stainless steel.
- Visible fixings, secured to wall by a 6-hole plate.
- Dimensions : 850 × 300 × 100mm.
- Wall plate thickness: 3.5mm.
- 30-year warranty.
- CE marked.

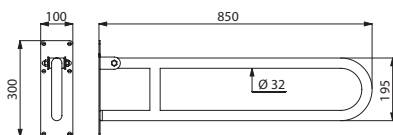

35164S

Basic drop-down support rail Ø 32mm - Polished satin 304 stainless steel	35164S
--	--------

### Related product

#### Toilet roll holder for grab bars

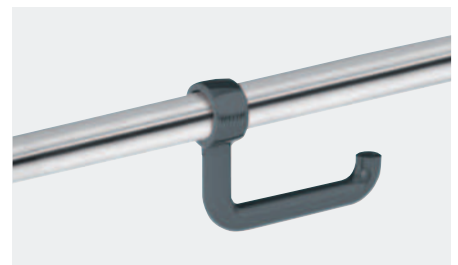

- For toilet rolls.
- High-strength polyamide (Nylon).
- Can be fitted without removing the grab bar.
- Anti-theft lock.
- Anti-rotating locking feature.
- For Ø 32 - Ø 34mm bars.
- 30-year warranty.

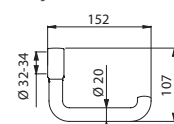

510081

Toilet roll holder for grab bars HR Nylon bright grey anthracite	510081
---	--------

**Bright ECO straight grab bar**

Tube Ø 25mm



- Bright polished 304 stainless steel.
- Visible fixings, secured to wall by a 3-hole plate.
- 30-year warranty.

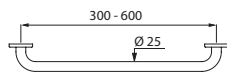

530/531/532/536

ECO straight grab bar Ø 25mm	
Bright polished 304 stainless steel - 300mm	<b>530</b>
Bright polished 304 stainless steel - 400mm	<b>531</b>
Bright polished 304 stainless steel - 500mm	<b>532</b>
Bright polished 304 stainless steel - 600mm	<b>536</b>

**Bright ECO angled grab bar 135°**

Tube Ø 25mm



- Bright polished 304 stainless steel.
- Visible fixings, secured to wall by a 3-hole plate.
- Dimensions: 220 × 220mm.
- 30-year warranty.

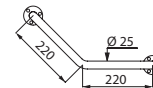

550

ECO angled grab bar 135° Ø 25mm Bright polished 304 stainless steel	<b>550</b>
--	------------

**White powder-coated ECO straight grab bar**

Tube Ø 25mm



- White powder-coated stainless steel.
- Visible fixings, secured to wall by a 3-hole plate.
- Dimensions: 300mm.
- 30-year warranty.

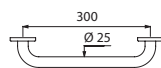

1530

ECO straight grab bar Ø 25mm White powder-coated stainless steel - 300mm	<b>1530</b>
---	-------------

**White powder-coated ECO angled grab bar 135°**

Tube Ø 25mm



- White powder-coated stainless steel.
- Visible fixings, secured to wall by a 3-hole plate.
- Dimensions: 220 × 220mm.
- 30-year warranty.

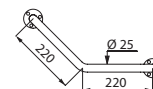

1550

ECO angled grab bar 135° Ø 25mm White powder-coated stainless steel	<b>1550</b>
--	-------------







# DOC M PRODUCTS AND PACKS

DOC M  
PACKS  
**152**

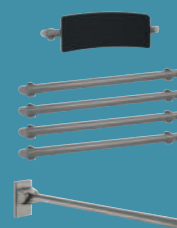
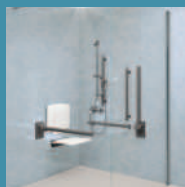
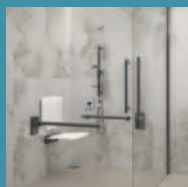

DOC M  
PRODUCTS  
**157**

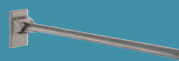

DOC M  
SPACE GUIDES  
**160**

### Recessed Be-Line® shower pack



Please note that the images are for illustration purposes only.

#### 19 items:

- 2 Drop-down support rails, 850mm
- 4 Grab bars, 600mm
- 2 Grab bars, 450mm
- 1 Lift-up shower seat
- 1 Backrest
- 1 Coat hook
- 1 SECURITHERM single lever sequential thermostatic recessed shower mixer with elbow outlet and Ø 16mm exposed shower column with reinforced collar
- 1 Chrome-plated TONIC JET shower head, tamperproof and scale-resistant, with automatic flow rate regulator set at 6 lpm
- 1 Recessed diverter valve
- 1 Single jet shower head and 1 flexible shower hose
- 1 Sliding shower head holder and 1 clip-on sliding soap dish
- 1 Shower hose retaining collar

*WRAS and TMV approval applied for.  
CE marked.*

DOC M Be-Line® Recessed shower pack	
Metallised anthracite powder-coated aluminium	511MREC1
Matte white powder-coated aluminium	511MREC2

## Exposed Be-Line® shower pack



Please note that the images are for illustration purposes only.

**19 items:**

- 2 Drop-down support rails, 850mm
- 4 Grab bars, 600mm
- 2 Grab bars, 450mm
- 1 Lift-up shower seat
- 1 Backrest
- 1 Coat hook
- 1 SECURITHERM single lever sequential thermostatic exposed shower mixer with elbow outlet and Ø 16mm exposed shower column with reinforced collar
- 1 Chrome-plated TONIC JET shower head, tamperproof and scale-resistant, with automatic flow rate regulator set at 6 lpm
- 1 Exposed diverter valve
- 1 Single jet shower head and 1 flexible shower hose
- 1 Sliding shower head holder and 1 clip-on sliding soap dish
- 1 Shower hose retaining collar

*WRAS and TMV renewal ongoing.*

*CE marked.*

DOC M Be-Line® Exposed shower pack	
Metallised anthracite powder-coated aluminium	<b>511MEXP1</b>
Matte white powder-coated aluminium	<b>511MEXP2</b>



Be-Line® WC pack with backrest **511809MC** - TEMPOMATIC dual control flush plate for WCs **464006** - Waterproof recessing housing **464SBOX**  
HIGHFLOW air pulse hand dryer **510622BK** - Electronic soap dispenser **512066BK** - Wall-mounted paper towel dispenser **510601BK**  
TEMPOMATIC 5 electronic basin tap **449006** - Toilet roll holder **510911BK** - Be-Line® toilet brush set **4051C + 4051M**

**Be-Line® WC pack with backrest**



- 1 backrest, depth 150mm (ref. 511928C or 511928W).
- 1 drop-down support rail, length 850mm.
- 4 grab bars, length 600mm.
- Aluminium tube.
- Choice of powder-coated metallised anthracite (LRV 14) or matte white (LRV 82) finish; provides a good visual contrast with the wall.
- Tested to over 200kg.
- Maximum recommended user weight: 135kg.
- 30-year warranty.
- CE marked.
- DOC M compliant.

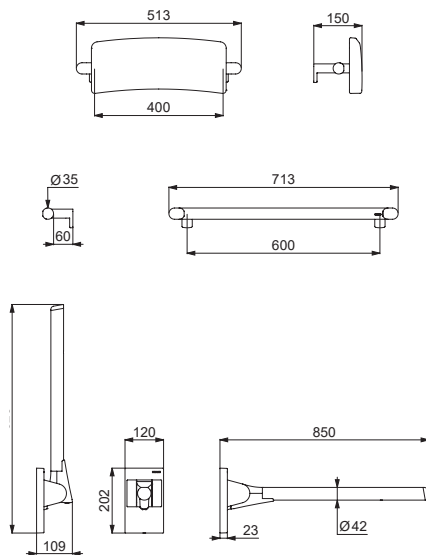

511809M

DOC M Be-Line® WC pack with backrest	
Metallised anthracite powder-coated aluminium	<b>511809MC</b>
Matte white powder-coated aluminium	<b>511809MW</b>

**Be-Line® WC pack**



- 1 drop-down support rail, length 850mm.
- 4 grab bars, length 600mm.
- Aluminium tube.
- Choice of powder-coated metallised anthracite (LRV 14) or matte white (LRV 82) finish; provides a good visual contrast with the wall.
- Tested to over 200kg.
- Maximum recommended user weight: 135kg.
- 30-year warranty.
- CE marked.
- DOC M compliant.

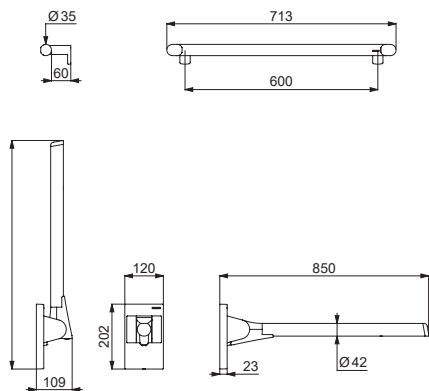

511804M

DOC M Be-Line® WC pack	
Metallised anthracite powder-coated aluminium	<b>511804MC</b>
Matte white powder-coated aluminium	<b>511804MW</b>

**Ambulant Be-Line® WC pack**



- 3 grab bars, length 600mm.
- Aluminium tube Ø 35mm.
- Choice of powder-coated metallised anthracite (LRV 14) or matte white (LRV 82) finish; provides a good visual contrast with the wall.
- Tested to over 200kg.
- Maximum recommended user weight: 135kg.
- 30-year warranty.
- CE marked.
- DOC M compliant.

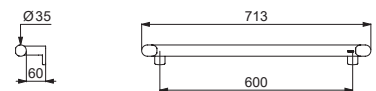

511811M

DOC M ambulant Be-Line® WC pack	
Metallised anthracite powder-coated aluminium	<b>511811MC</b>
Matte white powder-coated aluminium	<b>511811MW</b>



Be-Line® grab bar **511906MW** - TEMPOMATIC dual control flush plate for WCs **464006**  
TEMPOFIX 3 self-supporting frame system for WCs **564065** - Be-Line® toilet brush set **4051MW + 4051M** - Be-Line® toilet roll holder **511966W**

## Straight grab bar

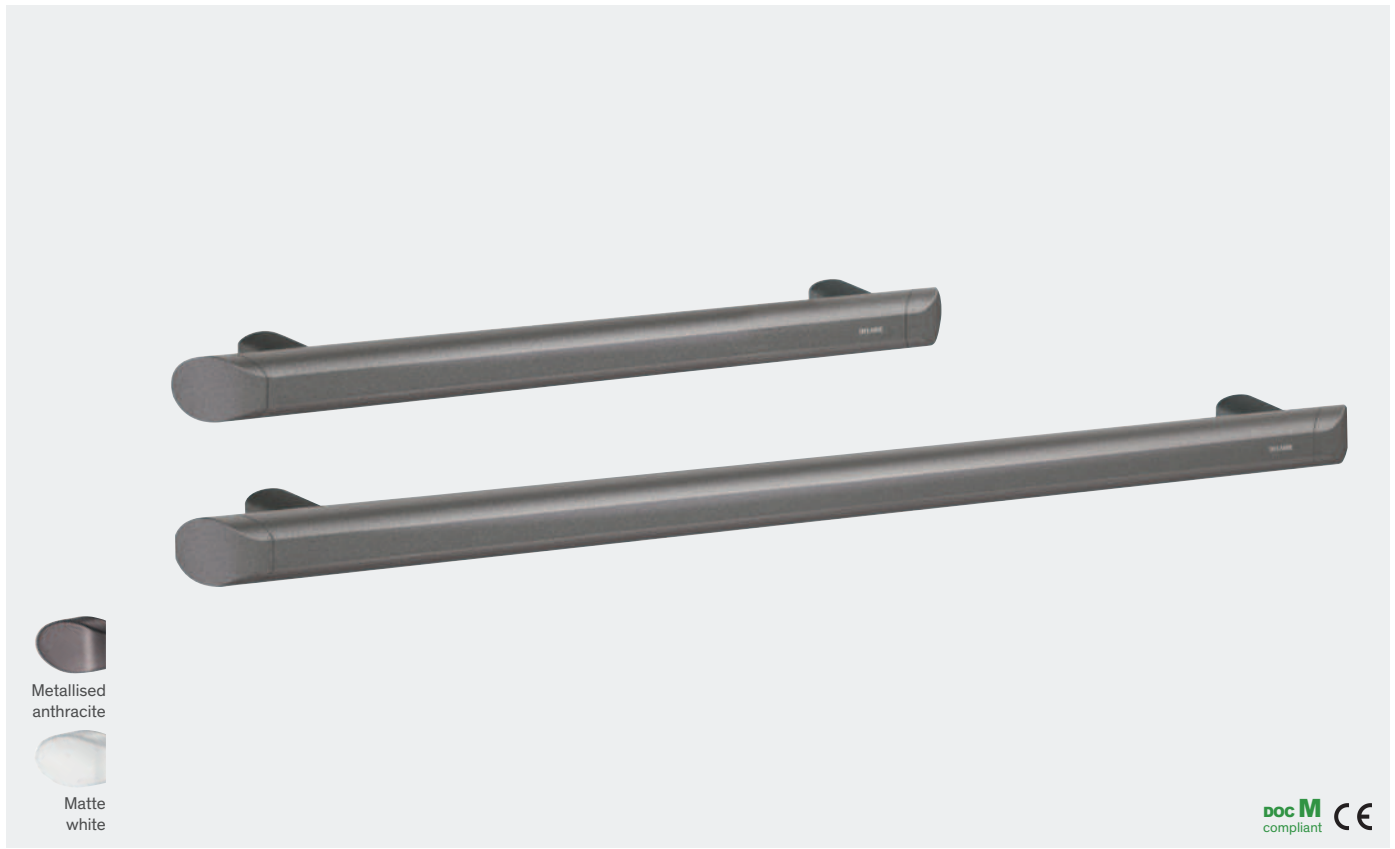

- For WCs, showers or baths.
- For use as a handrail and grab bar or support rail.
- Aluminium tube thickness 3mm. Solid aluminium fixing points.
- Rounded profile Ø 35mm with ergonomic flat front face that prevents rotation for an optimal grip.
- Choice of powder-coated metallised anthracite (LRV 14) or matte white (LRV 82) finish; provides a good visual contrast with the wall.
- Uniform surface for easy maintenance and hygiene.
- **60mm** gap between the bar and the wall: minimal space prevents the forearm passing between the bar and the wall, reducing the risk of fracture in case of loss of balance.
- Concealed fixings.
- Supplied with stainless steel screws Ø 8 × 70mm for concrete walls.
- Dimensions: 450 - 600mm centre-to-centre.
- Tested to over 200kg. Maximum recommended user weight: 135kg.
- 30-year warranty.
- CE marked.
- DOC M compliant.

DOC M Be-Line® grab bar - Metallised anthracite powder-coated aluminium	
450mm	511904MC
600mm	511906MC
DOC M Be-Line® grab bar - Matte white powder-coated aluminium	
450mm	511904MW
600mm	511906MW

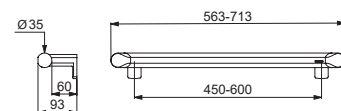

511904MC/511906MC/511904MW/ 511906MW





## Drop-down support rail



- For WCs or showers.
- Allows side access in the raised position.
- In the lowered position use as a grab bar, as a support for standing and for assisting movement.
- **Removable:** easy to remove with anti-theft locking system.
- **Slowed down descent. Retained in upright position.**
- Aluminium tube.
- Rounded profile  $\varnothing 42$ mm with ergonomic flat front face that prevents rotation for an optimal grip.
- Choice of powder-coated metallised anthracite (LRV 14) or matte white (LRV 82) finish; provides a good visual contrast with the wall.
- Uniform surface for easy maintenance and hygiene.
- Concealed fixings secured to wall by a 304 stainless steel plate, 5mm thick.
- Supplied with stainless steel screws  $\varnothing 8 \times 70$ mm for concrete walls.
- Dimensions:  $850 \times 202 \times 120$ mm.
- Tested to over 200kg. Maximum recommended user weight: 135kg.
- 30-year warranty.
- CE marked.
- DOC M compliant.

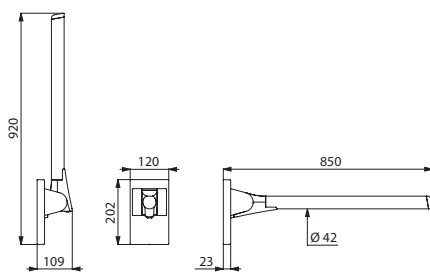

511964

### DOC M Be-Line® drop-down support rail

Metallised anthracite powder-coated aluminium	<b>511964C</b>
Matte white powder-coated aluminium	<b>511964W</b>

## Comfort backrest for WCs



- For WCs for people with reduced mobility.
- Flexible backrest made from polyurethane.
- Choice of powder-coated metallised anthracite (LRV 14) or matte white (LRV 82) finish, aluminium structure.
- Dimensions:  $150 \times 513 \times 173$ mm.
- 30-year warranty.
- CE marked.
- DOC M compliant.

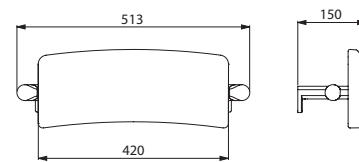

511928

### DOC M Be-Line® backrest for WCs

Metallised anthracite powder-coated aluminium	<b>511928C</b>
Matte white powder-coated aluminium	<b>511928W</b>

**DISABILITY DISCRIMINATION ACT (DDA) AND DOC M: REMOVING PHYSICAL BARRIERS**

From October 2004, the revised DDA requires that "All suppliers of services, goods and facilities for the general public must remove all physical barriers, where deemed reasonable". The DOC M (Part M of the Building Regulations 2010, volume 2) recommends and imposes a variety of alternative layouts and product combinations in response to these obligations.

DELABIE has therefore developed a product offering, including special packs, which conform to the recommendations of DOC M. The objective is to allow everyone - disabled people, older people or those with reduced mobility - easy access and to maintain maximum independence in their day-to-day life.

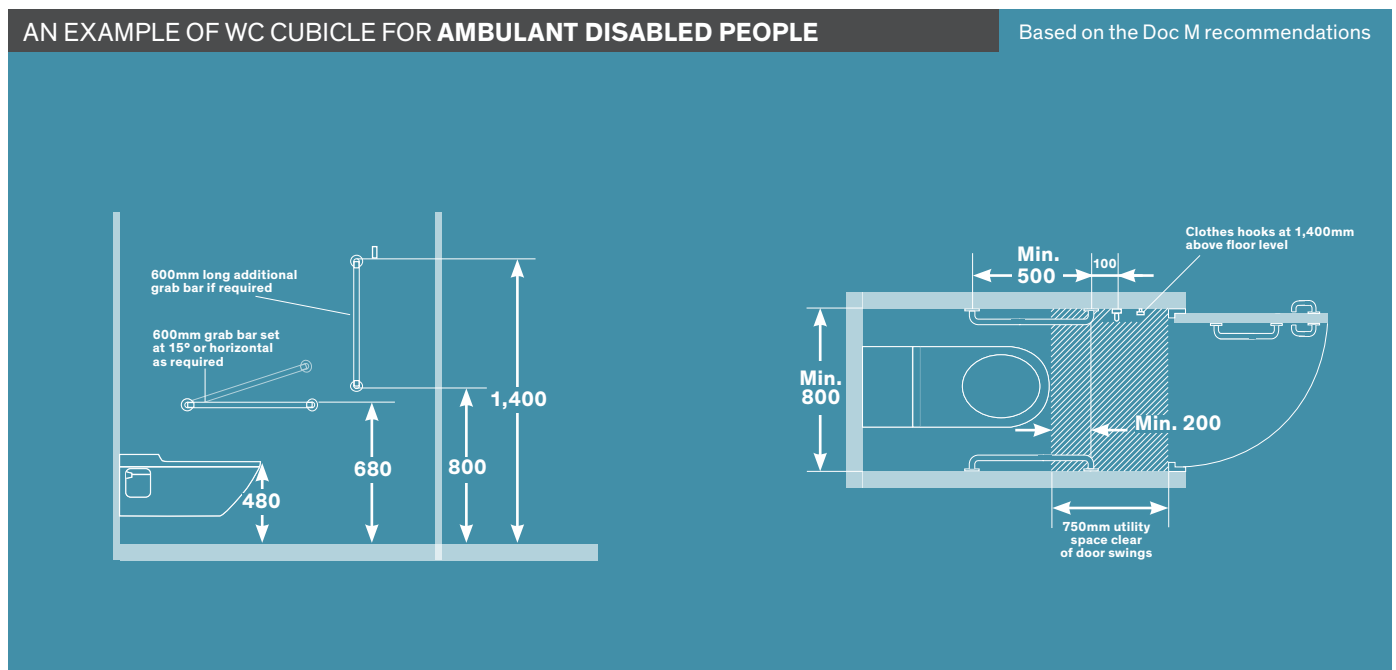
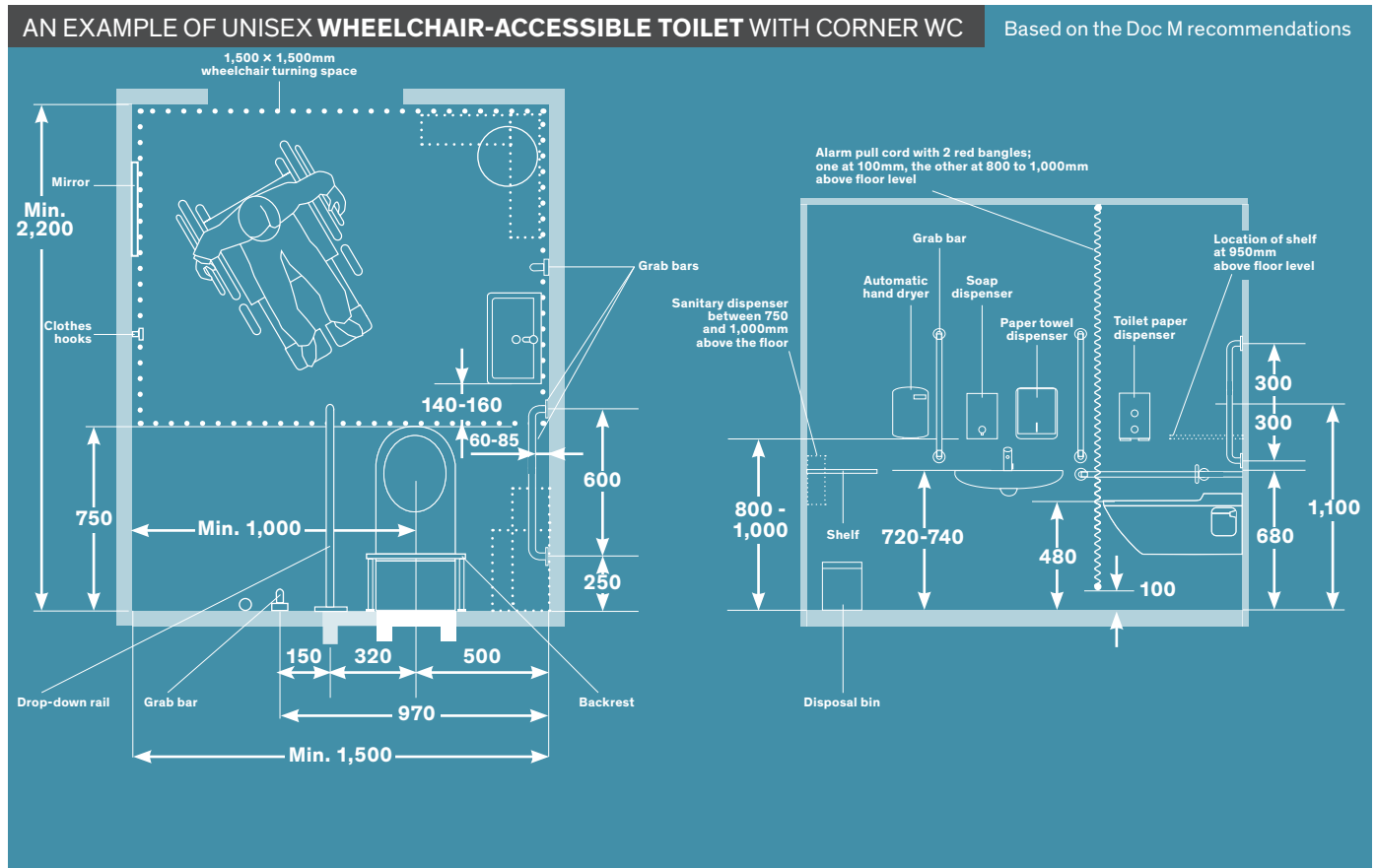

AN EXAMPLE OF A SELF-CONTAINED SHOWER ROOM FOR INDIVIDUAL USE

Based on the Doc M recommendations

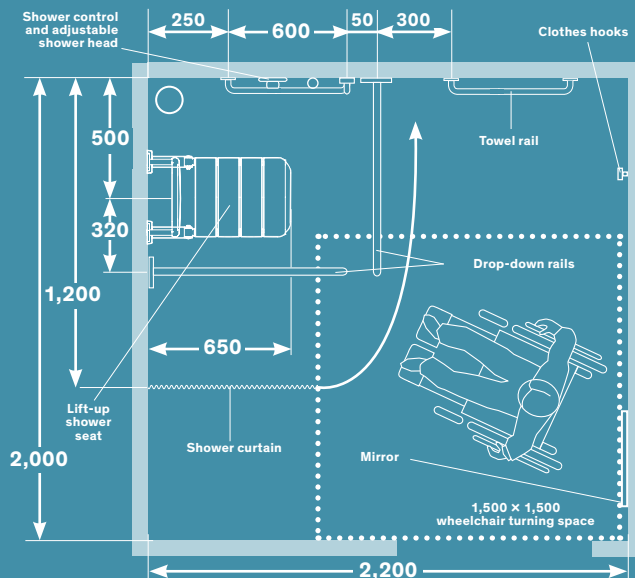
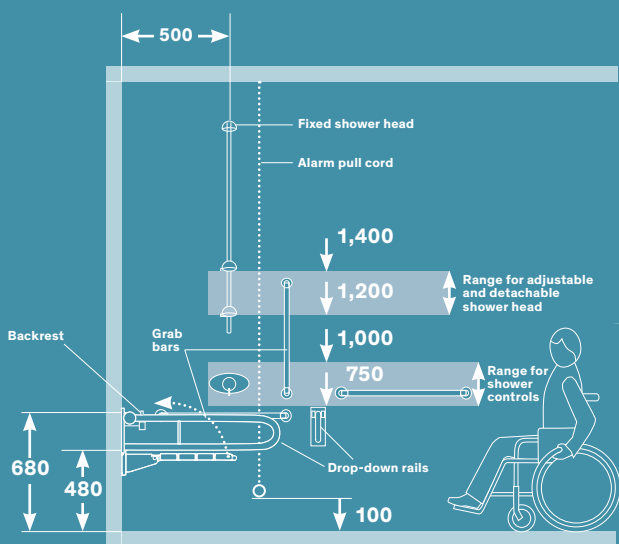

AN EXAMPLE OF A SELF-CONTAINED CHANGING ROOM FOR INDIVIDUAL USE

Based on the Doc M recommendations

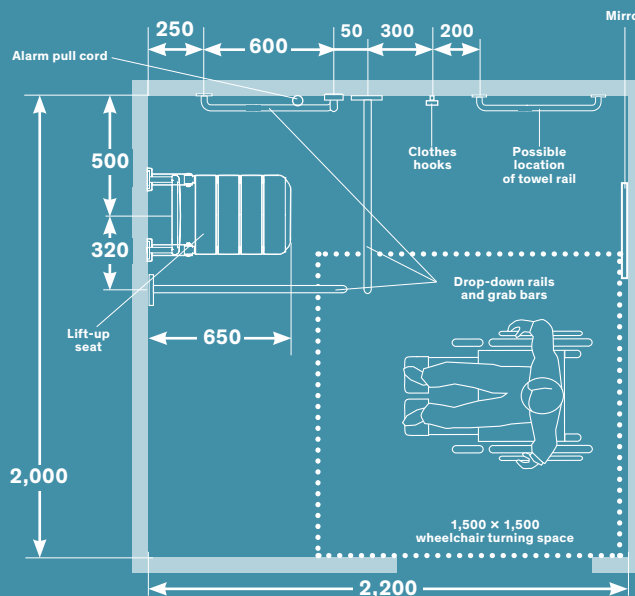
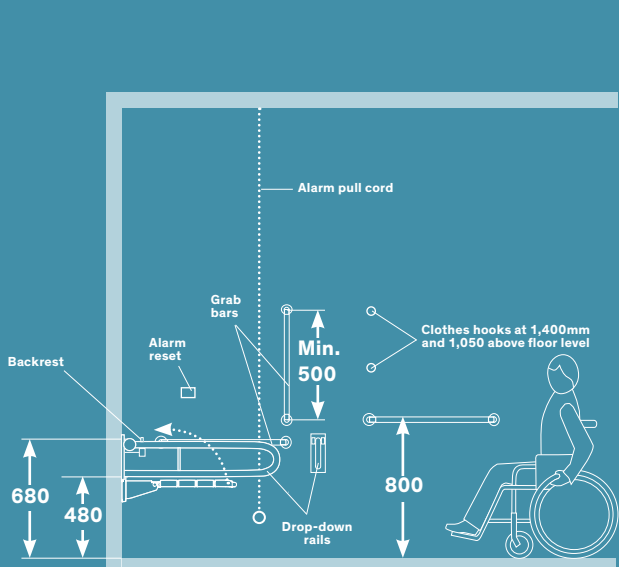

DOC M RANGE



## ACCESSIBILITY

Access is a right for people with reduced mobility. Architectural and technical provision must be made to allow everyone, disabled people, the elderly and those with reduced mobility, to **maintain maximum independence** in their day-to-day life.

In particular, they must have **easy access to all public places** such as civic buildings, cultural centres, hospitals, shops, buildings with communal living, individual housing...

## THE DELABIE SOLUTION

The DELABIE Group through its Accessibility and Independence – Hygienic Accessories range delivers **a complete range of grab bars and shower seats**, as well as accessories (mirrors, soap dispensers, coat hooks, hand dryers, etc.). Hence **facilities can be adapted** to meet the specific needs of all users, regardless of their age or level of independence.

This guide provides recommendations and advice for the correct installation of our products.

However, the information is provided for guidance only. **The information and installation advice must be adapted to the appropriate regulations where they exist (e.g. installation height, length, number of products and accessible facilities, layout, etc.). These may vary considerably from country to country.**

In order to meet these requirements, **sanitary installations** such as shower cubicles, changing rooms, wash basins and toilets should be adapted to ensure that they are suitable for disabled people.

For DOC M recommendations see pages 151 - 161.

### WCs

Every building providing public toilet facilities should incorporate a toilet that is accessible **by wheelchair users** and **an accessible washbasin** on every floor that has public access.

Disabled toilets should be installed near to non-disabled toilets so that they are grouped together.

If there are separate toilets for each sex, a disabled toilet should be available for each sex. Washbasins, or at least one washbasin per group of washbasins, should be accessible by disabled people, as well as the various fittings, especially **mirrors, soap dispensers and hand dryers**.

### Buildings with accommodation

All buildings that provide accommodation for the public must also provide rooms that are suitable for disabled use and that can be occupied by a person in a wheelchair.

Ratio of adapted rooms in relation to the total number of bedrooms in the building	
Up to 20 rooms	1 room
Up to 50 rooms	2 rooms
More than 50 rooms	1 additional room for every 50 rooms

### Buildings accommodating older people or people with a motor disability

All bedrooms or accommodation, bathrooms, showers and toilets must be suitable for disabled people.



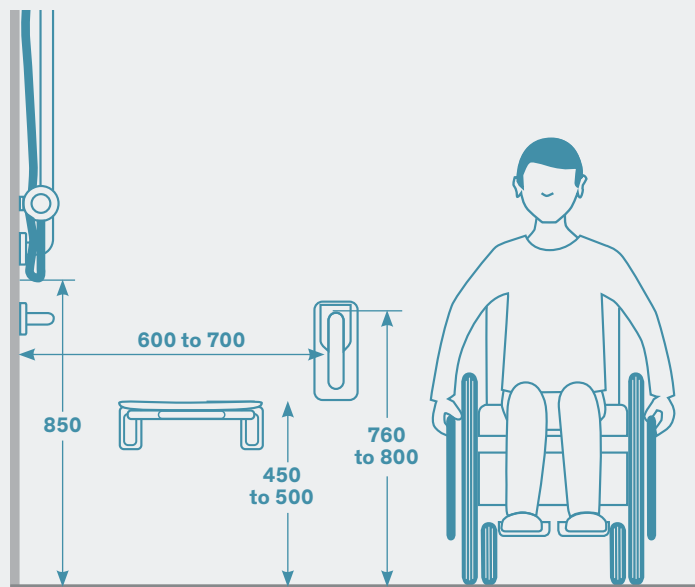
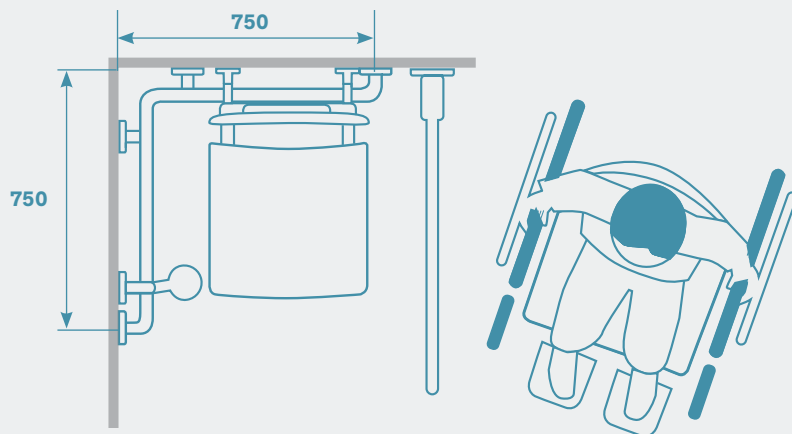
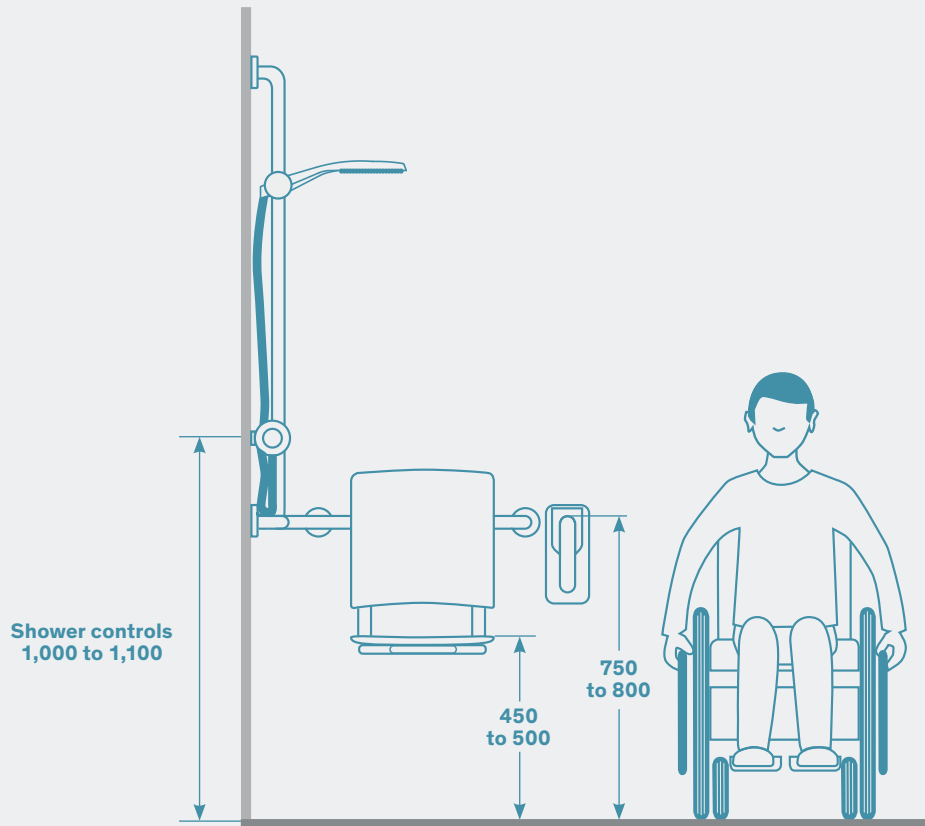

## SHOWERS

In buildings that provide showers or changing rooms (swimming pools, hotels, hospitals, retirement homes, etc.) showers should incorporate in principle:

- Equipment enabling people to sit down and access to a support when seated or standing: **a removable or lift-up shower seat, support bars with a vertical riser rail and drop-down support rails.**
- **A free space - known as a utility space (0.80m x 1.30m)** - next to the equipment, providing easy access for wheelchair users.
- Equipment accessible from the seated position: **adapted taps, coat hooks, mirrors, sliding shower head holders, etc.**
- A floor trap.

We recommend installing a thermostatic mixer with automatic anti-scalding failsafe - or a tap with a maximum temperature limiter - with a cool-touch body and ergonomic long lever (see our catalogue - [Water Controls for Hospitals](#)).

## CHANGING ROOMS

Changing rooms should similarly provide a seat with suitable support bars as well as a utility space 1,500mm in front of the lockers.

The various accessories should be equally accessible e.g. coat hooks, mirrors and hair dryers.

For DOC M recommendations see pages 151 - 161.

## Examples of suitable products



**Removable shower seat to hang on grab bars**  
Ref. 510300N



**Removable lift-up Be-Line® shower seat with leg**  
Ref. 511930C



**NylonClean drop-down support rail**  
Ref. 5160N



**Be-Line® two-wall grab bar with sliding vertical riser rail**  
Ref. 511949C



**UltraPolish stainless steel straight grab bars 300 - 900mm**  
Ref.s 5050, 50504, 50505...



**Sliding shower head holder and sliding soap dish**  
Ref.s 4110P and 510120



**Recessed thermostatic shower mixer**  
Ref. H9631L



**Slimline shower tray**  
Ref. 150500

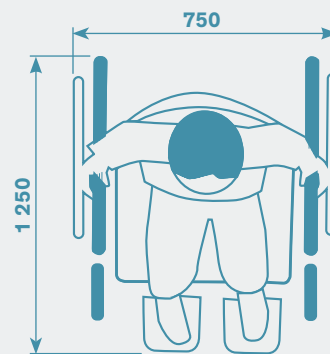
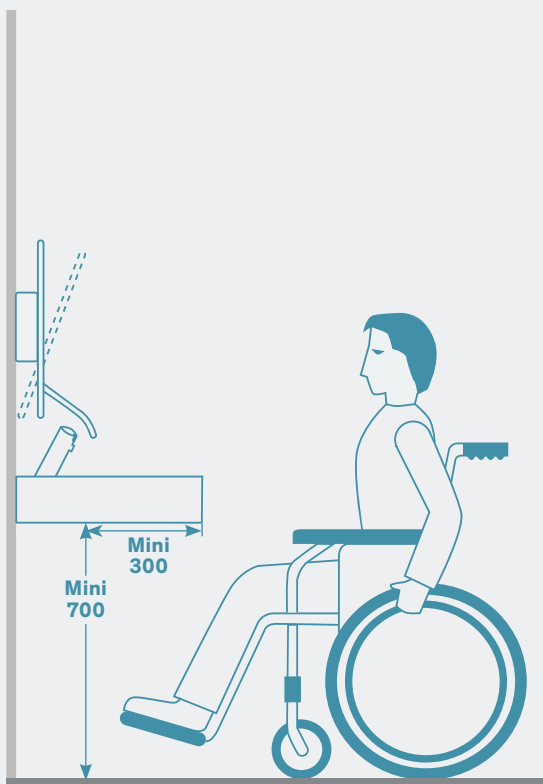
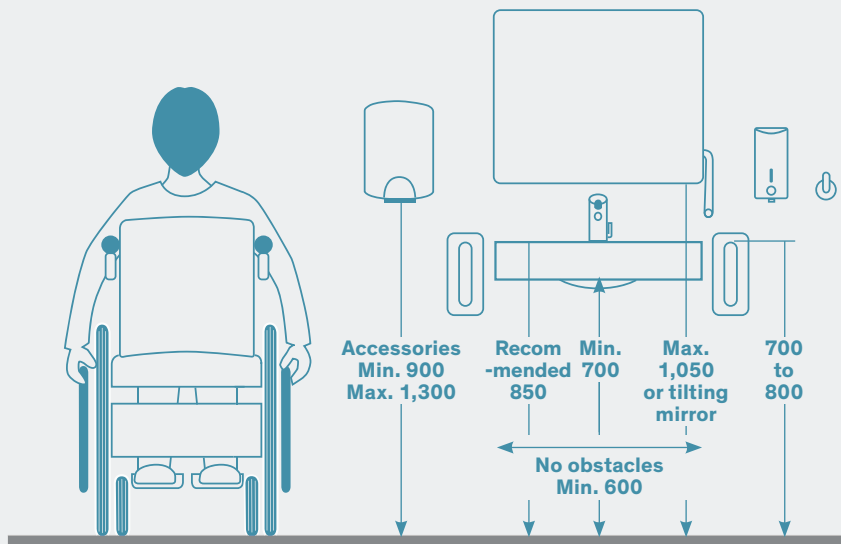

Standard dimensions  
 for a wheelchair



## WASHBASINS

Disabled WCs should incorporate **specific washbasins**.

The top of the washbasin should be installed at the recommended height of 850mm and there should be a free area at least 300mm deep, 600mm wide, at a height of 700mm, underneath the washbasin to allow easy access for wheelchair users.

Other equipment such as **hand dryers, soap dispensers and taps** should be accessible for users in a seated position and placed at a height between 900 and 1,300mm.

**A mirror** should also be installed. If the mirror does not tilt, the lower edge should be fixed at a maximum height of 1,050mm. **Grab bars** or a **washbasin support frame** may be added to provide additional safety and comfort.

We recommend installing an electronic or soft-touch time flow tap; or a tap with an ergonomic lever, with a maximum temperature limiter (see our catalogues [Commercial Water Controls](#), [Water Controls for Hospitals and Stainless Steel Sanitary Ware](#)).

For DOC M recommendations see pages 151 - 161.

## Examples of suitable products



**Drop-down support rail**  
Ref. 510160P



**Tilting mirror with long, ergonomic lever**  
Ref. 510201N



**Electronic soap dispenser**  
Ref. 512066P

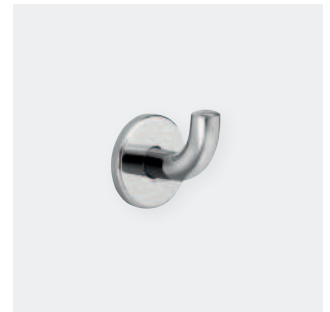

**Stainless steel coat hook**  
Ref. 4043P



**HIGHFLOW air pulse hand dryer**  
Ref. 510622



**MINERALCAST PMR washbasin**  
Ref. 132306



**Long lever mixer**  
Ref. 2721LEP



**Electronic mixer**  
Ref. 490006

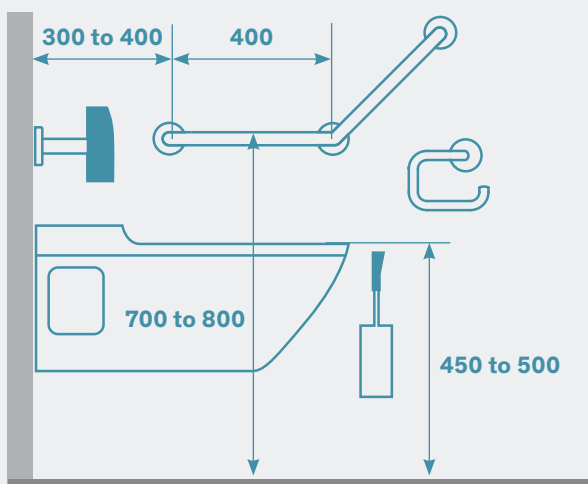
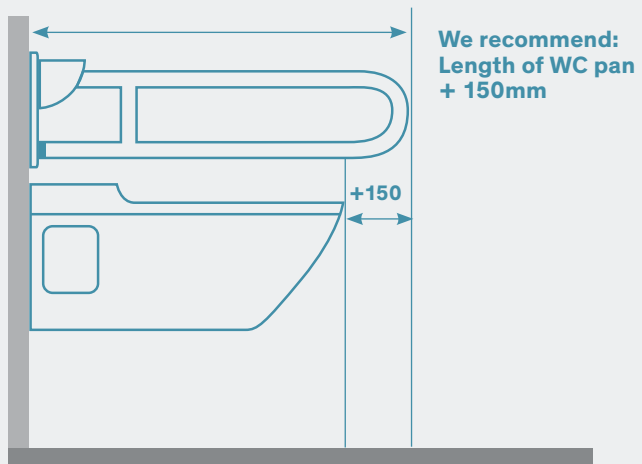
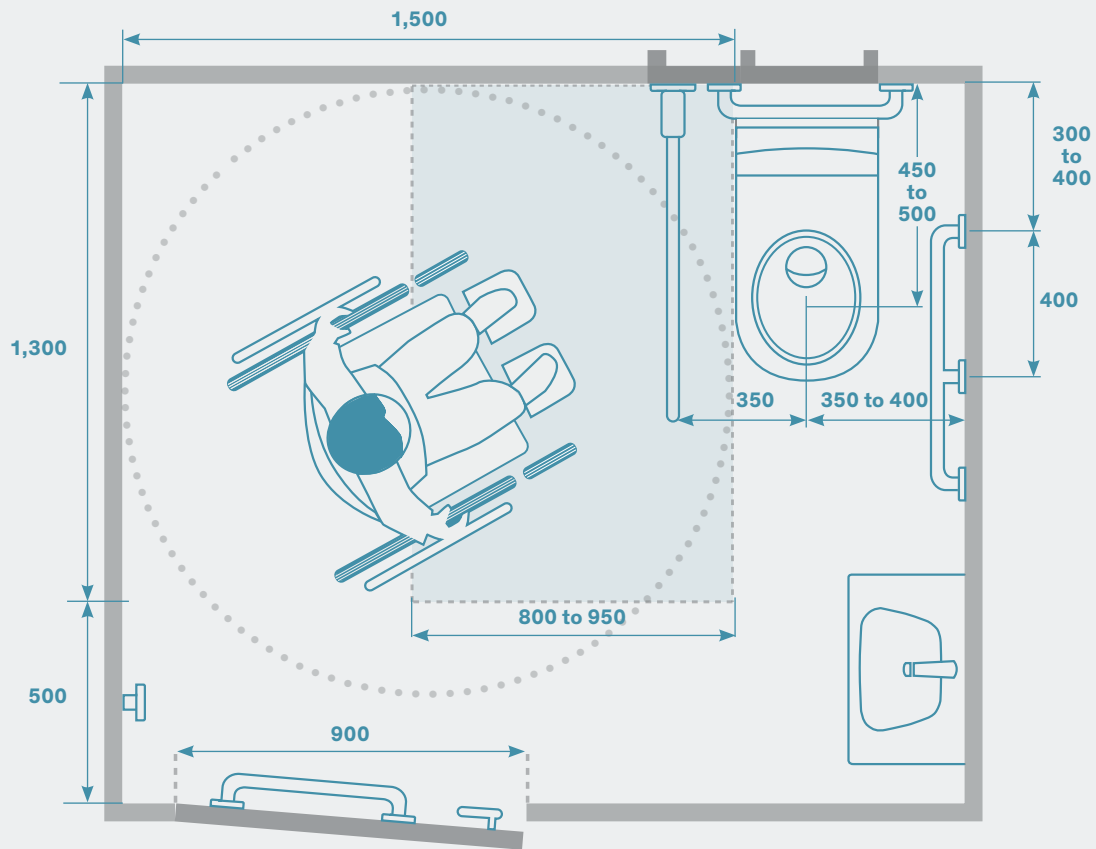

## WCs

In toilets, a utility space for turning and manoeuvring should be envisaged during construction.

The toilet seat should be installed between 450 and 500mm from the floor and **at least one support bar, to allow wheelchair users to transfer** to the toilet seat, should be installed at a height between 700 and 800mm. The support bars and their fixings should be able to withstand the full weight of an adult.

### A drop-down support rail will facilitate side access.

We recommend that the length of the support bar should equal that of the WC pan plus approximately 150mm. If the toilet does not have an exposed cistern, a backrest should be included to avoid any risk of the user falling backwards.

A rectangular space to manoeuvre, at least 800 × 1,300mm should be provided next to the WC pan and a **turning space of 1,500mm** should also be provided to allow a wheelchair to turn through 180 degrees.

We recommend mounting a **400mm grab bar** on the back of the door to help with closing/opening.

An electronic flush is ideal for disabled toilets.

A washbasin equipped with an electronic or time-flow tap/mixer valve with soft-touch operation, or ergonomic control lever, and with a temperature limiter must be installed (see our catalogues [Commercial Water Controls](#), [Water Controls for Hospitals and Stainless Steel Sanitary Ware](#)).

For DOC M recommendations see pages 151 - 161.

## Examples of suitable products



**UltraPolish stainless steel drop-down support rail**  
Ref. 510164P



**UltraPolish stainless steel grab bar 135°, 400 x 400mm**  
Ref. 5082P



**Be-Line® straight grab bars 300 - 900mm**  
Ref. 511903, 511904...

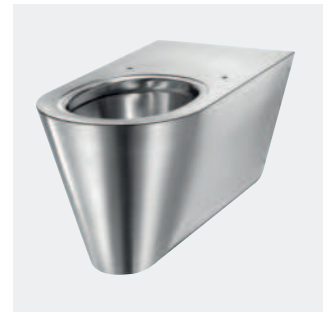

**WC with 700mm pan**  
Ref. 110710



**Frame system with TEMPOMATIC dual control electronic WC valve**  
Ref. 564065 + 464006

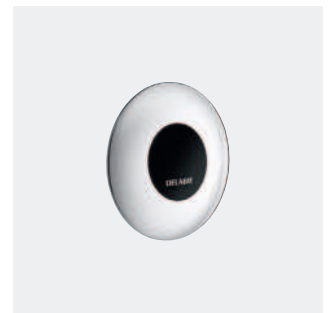

**TEMPOMATIC WC cross wall electronic flush valve**  
Ref. 463150



**Ergonomic toilet brush set**  
Ref. 4051P + 4051M



**PMR XS washbasin**  
Ref. 120400



# Spare parts Reference index

SPARE  
PARTS  
**172**

---

REFERENCE INDEX  
**174**

---

## ACCESSIBILITY

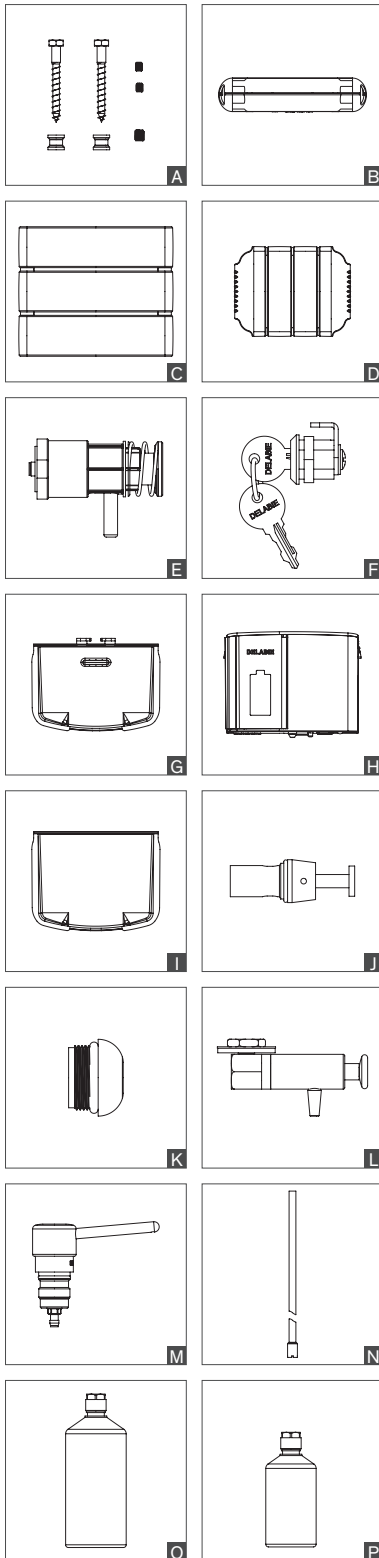

	Repair kit	Type
<b>Be-Line®</b>		
Fixing kit	5119FIX	A
Fixing kit for DOC M grab bars	5119MFIX	-

## SOAP DISPENSERS

	Repair kit	Complete mechanism	Type
<b>510580-510581-510582-510583-510584-510586</b>			
Pump	51058M	-	E
Lock	SER2911V	-	F
<b>512066</b>			
Electronic unit + O-ring	51206BC	-	H
Lock	SER2911V	-	F
<b>6566 - 6567</b>			
Complete valve only	6568	-	J
Level control window only	6569	-	K
<b>6580 - 6583</b>			
Pump	6580SRV	-	L
<b>729xxx</b>			
729008, 729108, 729508	729302	729308	M
729012, 729112, 729512	729302	729312	M
729150, 729200	729302	729303	M
PVC tube + non-return valve carrier & non-return valve	729TUB	-	N
1L tank, for ref.s 729008, 729112	729501	-	O
0.5L tank, for ref.s 729508, 729512	729500	-	P

## HAND DRYERS

	Repair kit	Type
<b>SPEEDJET 510621</b>		
Filter (after 2013)	510621F	A
Filter (before 2013)	510621FA	B
Drip tray	510621R	C
<b>SPEEDJET 2 510623 without drip tray</b>		
HEPA filter for hand dryer without drip tray	510623F	D
<b>SPEEDJET 2 510624 with drip tray</b>		
HEPA filter for hand dryer with drip tray	510624F	E
Drip tray for SPEEDJET 2 in black	510624RB	F
Drip tray for SPEEDJET 2 in anthracite	510624RC	F
Drip tray for SPEEDJET 2 in white	510624RW	F

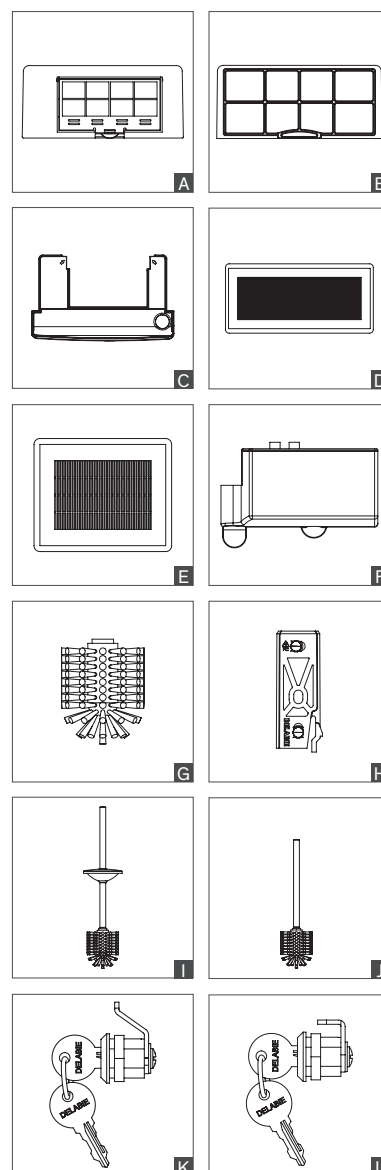

## TOILET BRUSH SET

	Repair kit	Type
Brush without handle	4051L	G
Wall bracket & fixings for toilet brush set 4048, 4051 & 510051	4051FIX	H
<b>Bright polished stainless steel</b>		
Toilet brush set with lid in bright polished stainless steel for ref.s 4050P, 4051P, 510050P & 510051P	4051MLP	I
Toilet brush set without lid in bright polished stainless steel for ref.s 4048P & 4049P	4048MLP	J
<b>Polished satin stainless steel</b>		
Toilet brush set with lid in polished satin stainless steel for ref.s 4050S, 4051S, 510050S & 510051S	4051MLS	I
Toilet brush set without lid in polished satin stainless steel for ref.s 4048S & 4049S	4048MLS	J
<b>White powder-coated stainless steel</b>		
Toilet brush set with lid in white powder-coated stainless steel for ref.s 4050EW, 4051EW, 510050W & 510051W	4051MLW	I
Toilet brush set without lid in white powder-coated stainless steel for ref.s 4048EW & 4049EW	4048MLW	J
<b>Metallised anthracite stainless steel</b>		
Toilet brush set with lid in metallised anthracite stainless steel for ref.s 4051C & 510051C	4051MLC	I
Toilet brush set without lid in metallised anthracite stainless steel for ref. 4048C	4048MLC	J
<b>Matte white powder-coated stainless steel</b>		
Toilet brush set with lid in matte white powder-coated stainless steel for ref.s 4051MW & 510051MW	4051MLMW	I
Toilet brush set without lid in matte white powder-coated stainless steel for ref. 4048MW	4048MLMW	J

## TOILET PAPER DISPENSERS

	Repair kit	Type
Lock for toilet paper dispenser for 2 rolls ref.s 1660, 1660S & 1661	SER1660V	K
Lock for ref.s 2900, 2901, 2902, 2910, 2911 & 2912	SER2911V	L

## PAPER TOWEL DISPENSERS

	Repair kit	Type
Lock for ref.s 2561D, 6601, 6602, 6607D, 6611, 6612 & 6617	SER2559V	L

REF.	DESCRIPTION	P.	REF.	DESCRIPTION	P.
101P	Hat & coat hook polished stainless steel	46	350506S	Basic grab bar Ø32 L600 stainless steel satin finish	147
110700	700 P floor standing WC horizontal inlet 304 st steel satin	110	350506W	Basic grab bar Ø32 L600 white powder-coated	144
110710	700 S wall mtd WC horizontal inlet 304 stainless steel satin	110	350508S	Basic grab bar Ø32 L800 stainless steel satin finish	147
110790	MONOBLOCO 700 PMR WC 304 stainless steel satin with cistern	110	350509S	Basic grab bar Ø32 L900 stainless steel satin finish	147
120270	TRAPEZ basin no tap hole 304 satin st. steel w/o overflow	-	35050S	Basic grab bar Ø32 L300 stainless steel satin finish	147
120400	PMR XS basin vert waste no tap hole 304 satin stainless steel	111	35050W	Basic grab bar Ø32 L300 white powder-coated	144
120440	FRAJU PMR basin no tap hole no overflow 304 st steel satin	111	35082S	Basic grab bar 135° Ø32 400×400 3 fix points st steel satin	147
121270	TRAPEZ basin Ø35 ctr tap hole 304 satin st. steel w/o overflow	-	35082W	Basic grab bar 135° Ø32 400×400 3 fix points white pwd-ctd	144
121440	FRAJU PMR basin tap hole Ø35 no overflow 304 st steel satin	111	35164S	Basic drop-down rail Ø32 L850 stainless steel satin finish	147
123400	PMR XS basin vert waste Ø35 right tap hole 304 satin st steel	111	35440W	Basic T-shaped shower handrail Ø32 1150×500 white pwd-ctd	144
1301W	*Robe hook 1 hook ss + metal wht pwd-ctd (whl stk then 301)	-	35481W	Shower bar + upright Basic Ø32 white powder coated	145
1302W	*Robe hook 2 hooks ss + metal wht pwd-ctd (whl stk then 302)	-	355	Straight curtain rail polished st steel Ø16 - 1m cut-to-size	53
1303W	*Robe hook 3 hooks ss + metal wht pwd-ctd (whl stk then 303D)	-	356	Straight curtain rail polished st steel Ø16 - 2m cut-to-size	53
132306	MINERALCAST PMR wall mounted basin L.785 Ø35 centre hole	135	3565	Toilet roll holder white powder-coated 304 stainless steel	35
1358	ECO telescopic curtain rail Ø20 - 0.8-2.10m polished alu	53	3569	Wall mounted soap basket angled model polished st steel	33
1367	Angled curtain rail Ø20 - 0.9×0.9m polished stainless steel	53	358	ECO telescopic curtain rail Ø20 - 0.76-1.26m polished alu	53
1381	Shower curtain 0.9×2m white PVC	55	359	Extending curtain rail Ø20 polished stainless steel	53
1382	Shower curtain 1.2×2m white PVC	55	360	Discontinued	-
1386	Shower curtain 1.8×2m white PVC	55	361	*Angled curtain rail Ø16 - 0.8×0.8m pol. ss (while stock)	-
1449	Round pedal bin 3L white powder-coated	20	362	Adj angled curtain rail 0.7-0.9m polished stainless steel	53
150500	PMR 800×800 shower tray depth 30mm 304 stainless steel satin	111	374001	Hypereco liquid soap dispenser 0.9L white ABS	57
150600	PMR 900×900 shower tray depth 30mm 304 stainless steel satin	111	379	*Non slip shower mat white rubber (while stock then 447)	-
1530	ECO grab bar Ø25 L300 white powder-coated stainless steel	148	381	Shower curtain 0.9×1.8m white PVC	55
1550	ECO grab rail 135° Ø25 220×220 white pwd-ctd stainless steel	148	382	Shower curtain 1.2×1.8m white PVC	55
1660	Toilet paper dispenser 2 rolls polished 304 stainless steel	35	387	Shower curtain 1.8×1.8m white PVC	55
1660S	Toilet paper disp. 2 rolls 304 stainless steel satin finish	35	390	6 × Shower curtain rings chrome plated brass	55
1661	Toilet paper disp. 2 rolls white pwd-ctd 304 stainless steel	35	390BIS	6 × Shower curtain rings plastic	55
2359	Straight curtain rail polished st steel Ø20 - 1m cut-to-size	53	4042P	Robe hooks x 2 hooks polished stainless steel	47
2390	Sleeve connector for 2 tubes Ø20	52	4042S	Robe hooks x 2 hooks polished satin stainless steel	47
2392	2 × Fixing plates for tube Ø20	52	4042W	Robe hooks x 2 hooks white powder-coated stainless steel	47
2393	Angled connector for tube Ø20	52	4043BK	Coat hook Ø62×65 matte black stainless steel	47
2396	Polished stainless steel tube Ø20 L600	52	4043EW	Coat hook Ø62 × 65 white powder-coated stainless steel	47
2397	Polished stainless steel tube Ø20 L700	52	4043N	Coat hook Ø62×65 Nylon	47
2398	Polished stainless steel tube Ø20 L800	52	4043P	Coat hook Ø62×65 polished stainless steel	47
2399	Polished stainless steel tube Ø20 L900	52	4043S	Coat hook Ø62×65 stainless steel satin finish	47
2400	Polished stainless steel tube Ø20 L1000	52	4047EW	*Coat hook Ø62×100 white pwd-ctd ss (while stock then 4043EW)	-
2561D	Dispenser and bin for hygienic bags polished stainless steel	41	4047P	Coat hook Ø62×100 polished stainless steel	47
2561DS	Dispenser and bin for hygienic bags satin stainless steel	41	4048C	WC brush set wall mtd without lid metallised anth. st steel	80
2900	Toilet paper dispenser 200m white lacquered steel	37	4048EW	WC brush set wall mounted without lid white pwd-ctd st steel	39
2901	Toilet paper dispenser 200m polished 304 stainless steel	37	4048MLC	WC brush assembly without lid metallised anthr. st steel	173
2902	Toilet paper dispenser 200m 304 stainless steel satin finish	37	4048MLMW	WC brush assembly without lid matte white pwd-ctd st steel	173
2909	Hypereco toilet paper dispenser 400m white ABS	57	4048MLP	WC brush assembly without lid polished st steel	173
2910	Toilet paper dispenser 400m white lacquered steel	37	4048MLS	WC brush assembly without lid stainless steel satin	173
2911	Toilet paper dispenser 400m polished 304 stainless steel	37	4048MLW	WC brush set assembly without lid white epoxy st steel	173
2912	Toilet paper dispenser 400m 304 stainless steel satin finish	37	4048MW	WC brush set wall mtd without lid matte white pwd-ctd st steel	80
301	Robe hook x 1 hook polished stainless steel and chrome	46	4048P	WC brush set wall mounted without lid polished st steel	39
302	Robe hook x 2 hooks polished stainless steel and chrome	46	4048S	WC brush set wall mounted without lid stainless steel satin	39
303D	Robe hook x 3 hooks polished stainless steel and chrome	46	4049EW	*WC brush set flr std w/o lid wht ss (whl stock then 4048EW)	-
3361	Hypereco WC brush set wall or floor mounted	56	4049P	WC brush set floor standing without lid polished st steel	39
3362	Toilet brush Nylon (for brush set 3361)	56	4049S	WC brush set floor standing without lid st steel satin	39
3364	Eco ceiling support L800 for rail Ø16 st steel + brass	54	4050EW	*WC brush set flr std with lid wht ss (whl stk then 4051EW)	-
3365	Eco ceiling support L800 for rail Ø20 st steel + brass	54	4050P	WC brush set floor standing with lid polished st steel	39
3372	*Ceiling supp. L1000 for rail Ø16 pol ss (whl stk then 3364)	-	4050S	WC brush set floor standing with lid st steel satin finish	39
3450	Rectangular bathroom mirror 420×600 6mm thick	44	4051BK	WC brush set wall mtd with lid matte black stainless steel	39
3451	Rectangular bathroom mirror 360×480 6mm thick	44	4051C	WC brush set wall mounted with lid metallised anth. st steel	80
3452	Unbreakable bathroom mirror 10×385×485 mirror pol st steel	45	4051EW	WC brush set wall mounted with lid white pwd-ctd st steel	39
3453	Unbreakable bathroom mirror 1×400×600 polished st steel	45	4051FIX	Wall bracket for toilet brush set type 4051	173
3454	Rectangular bathroom mirror 500×750 6mm thick	44	4051L	WC brush without handle	173
3458	Unbreakable bathroom mirror 10×485×585 mirror pol st steel	45	4051M	Extended ergonomic handle for toilet brushes	39/80
3459	Unbreakable bathroom mirror 10×595×980 mirror pol st steel	45	4051MLBK	WC brush assembly with lid matte black stainless steel	-
350504S	Basic grab bar Ø32 L400 stainless steel satin finish	147	4051MLC	WC brush assembly with lid metallised antracite st. steel	173
350504W	Basic grab bar Ø32 L400 white powder-coated	144	4051MLMW	WC brush assembly with lid matte white powder-coated st. steel	173
350505S	Basic grab bar Ø32 L500 stainless steel satin finish	147	4051MLP	WC brush assembly with lid polished stainless steel	173
350505W	Basic grab bar Ø32 L500 white powder-coated	144	4051MLS	WC brush assembly with lid stainless steel satin	173

References prefixed by \* are available while stocks last. References are listed in ascending alphanumerical order.



REF.	DESCRIPTION	P.
4051MLW	WC brush assembly with lid white epoxy st steel	173
4051MW	WC brush set wall mtd with lid matte white pwd-ctd st steel	80
4051N	WC brush wall mounted with ergonomic handle white Nylon	40
4051P	WC brush set wall mounted with lid polished stainless steel	39
4051S	WC brush set wall mounted with lid stainless steel satin	39
4070N	Spare toilet roll holder white Nylon	35
4070P	Spare toilet roll holder polished stainless steel	35
4070S	Spare toilet roll holder polished satin stainless steel	35
4081EW	U-shaped toilet roll holder white pwd-ctd stainless steel	34
4081N	U-shaped toilet roll holder white Nylon	34
4081P	U-shaped toilet roll holder polished stainless steel	34
4081S	U-shaped toilet roll holder stainless steel satin finish	34
4110P	Shower head holder chrome plated metal for bar Ø25 & Ø32	104
423	*Lift-up shower seat with slats (while stock then 510420)	-
435	*Toilet booster seat with lid white plastic (while stock)	-
4359	Straight curtain rail polished st steel Ø20 - 2m cut-to-size	53
4373	Ceiling support L1000 for rail Ø20 polished stainless steel	54
447	Non slip duck board semi-rigid white plastic	55
449	Round pedal bin 3L polished stainless steel	20
450P	Round pedal bin 5L polished stainless steel	20
460	Wall mounted rectangular bin 13L polished stainless steel	20
462	Wall mounted rectangular bin with cover 13L pol st steel	20
465	Slimline wall mounted rectangular bin 4,5L polished st steel	20
465S	Slimline wall mounted rectangular bin 4.5L satin st. steel	20
50504N	Grab bar Ø32 L400 white Nylon	122
50504P2	Grab bar Ø32 L400 polished stainless steel	91
50504S	Grab bar Ø32 L400 Stainless steel satin finish	91
50505N	Grab bar Ø32 L500 white Nylon	122
50505P2	Grab bar Ø32 L500 polished stainless steel	91
50505S	Grab bar Ø32 L500 stainless steel satin finish	91
50506N	Grab bar Ø32 L600 white Nylon	122
50506P2	Grab bar Ø32 L600 polished stainless steel	91
50506S	Grab bar Ø32 L600 stainless steel satin finish	91
50509N	Grab bar Ø32 L900 white Nylon	122
50509P2	Grab bar Ø32 L900 polished stainless steel	91
50509S	Grab bar Ø32 L900 Stainless steel satin finish	91
5050N	Grab bar Ø32 L300 white Nylon	122
5050P2	Grab bar Ø32 L300 polished stainless steel	91
5050S	Grab bar Ø32 L300 stainless steel satin finish	91
50510S	Grab bar Ø32 L.1050 Stainless steel satin	-
5055P2	*Grab bar Ø25 L300 pol. stain st. (while stock then 5050P2)	-
5056P2	*Grab bar Ø25 L400 pol. stain st. (while stock then 50504P2)	-
5057P2	*Grab bar Ø25 L500 pol. stain st. (while stock then 50505P2)	-
5058P2	*Grab bar Ø25 L600 pol. stain st. (while stock then 50506P2)	-
5059P2	*Grab bar Ø25 L900 pol. stain st. (while stock then 50509P2)	-
5070DP2	L-shaped handrail (right) Ø32 H750 polished stainless steel	99
5070DS	L-shaped handrail (right) Ø32 H750 stainless steel satin	99
5070GP2	L-shaped handrail (left) Ø32 H750 polished stainless steel	99
5070GS	L-shaped handrail (left) Ø32 H750 stainless steel satin	99
5070N	L-shaped handrail Ø32 H750 white Nylon	127
5071DP2	L-shaped handrail (right) Ø32 H1150 polished stainless steel	99
5071DS	L-shaped handrail (right) Ø32 H1150 stainless steel satin	99
5071GP2	L-shaped handrail (left) Ø32 H1150 polished stainless steel	99
5071GS	L-shaped handrail (left) Ø32 H1150 stainless steel satin	99
5071N	L-shaped handrail Ø32 H1245 white Nylon	127
5081N	Grab rail 135° Ø32 400×400 3 fixing points white Nylon	121
5081P2	Grab rail 135° Ø32 400×400 2 fix. points polished st steel	93
5081S	Grab rail 135° Ø32 400×400 2 fixing points st steel satin	93
5082P	Grab rail 135° Ø32 400×400 3 fix. points polished st steel	93
5082S	Grab rail 135° Ø32 400×400 3 fixing points st steel satin	93
5082W	Grab rail 135° Ø32 400×400 3 fix points wht pwd-ctd st steel	93
5083N	Grab rail 135° Ø32 220×220 3 fix. points wht Nylon	121
5083P	Grab rail 135° Ø32 220×220 2 fix. points polished st steel	93
5083S	Grab rail 135° Ø32 220×220 2 fixing points st steel satin	93

REF.	DESCRIPTION	P.
5086P2	Grab rail 135° Ø25 400×400 2 fix. points polished st steel	93
5087P	Grab rail 135° Ø25 400×400 3 fix. points polished st steel	93
510042N	Double hook white Nylon	47
510043N	Single hook white Nylon	47
510047BK	Matte black stainless steel coat hook	46
510047P	Bright polished stainless steel hook	46
510047S	Satin finish stainless steel hook	46
510047W	White powder coated stainless steel hook	46
510050P	*WC brush set lid + ergo hdlr pol. (whl stk then 4050P+4051M)	-
510050S	*WC brush set lit + ergo hdlr sat. (whl stk then 4050S+4051M)	-
510050W	*WC brush set lit + ergo hdlr wht (whl stk then 4050EW+4051M)	-
510051C	*WC brush w-mtd lid + ergo hdlr anth. (whl stk thn4051C+4051M)	-
510051MW	*WC brush w-mtd lid + ergo hdlr wht (whl stk then 4051EW+4051M)	-
510051P	*WC brush w-mtd lid + ergo hdlr pol. (whl stk then 4051P+4051M)	-
510051S	*WC brush w-mtd lid + ergo hdlr sat. (whl stk then 4051S+4051M)	-
510051W	*WC brush w-mtd lid + ergo hdlr wht (whl stk then 4051EW+4051M)	-
510081	Toilet roll holder for bars Ø32-34 grey Nylon	105
510081N	Toilet roll holder for bars Ø32-34 white Nylon	133
510081P	Toilet roll holder for bars Ø32-34, chrome-plated	105
510082P	Double toilet roll holder bright polished stainless steel	34
510082S	Double toilet roll holder polished satin stainless steel	34
510082W	Double toilet roll holder powder-coated stainless steel	34
510083BK	Single toilet roll holder matte black stainless steel	34
510083P	Single toilet roll holder bright polished stainless steel	34
510083S	Single toilet roll holder polished satin stainless steel	34
510083W	Single toilet roll holder powder-coated stainless steel	34
5100DP2	*Right-angled bar (right) Ø32 pol. ss. (whl stk then 5481P)	-
5100DS	*Right-angled bar (right) Ø32 ss sat. (whl stock then 5481S)	-
5100GP2	*Right-angled bar (left) Ø32 pol. ss (while stock then 5481P)	-
5100GS	*Right-angled bar (left) Ø32 ss sat. (while stock then 5481S)	-
5100N	Right-angled bar Ø32 white Nylon	125
510104S	Anti-lig coat hook Ø90 304 st steel satin (ex-0011040000)	46
510110	Shower head holder white Nylon for bar Ø32	132
510110NG	Shower head holder grey Nylon for bar Ø32	104
510120	Clip-on sliding shower soap dish clear for bar Ø25&32	105
510120N	Clip-on sliding shower soap dish white Nylon for bar Ø25&32	132
510150	Chrome-plated cover plate (bars 510160-510164-510162-510170)	95
510150N	Cover plate white Nylon (for bars 5160N-5164N-5162N-5170N)	123
510151S	Female wall sticker 304 st steel satin (ex-0011410000)	48
510152S	Male wall sticker 304 stainless steel satin (ex-0011400000)	48
510153S	Disabled wall sticker 304 st steel satin (ex-0011370000)	48
510154S	WC wall sticker 304 stainless steel satin (ex-0011420000)	48
510155S	Mixed disabled sticker 304 st steel satin (ex-0011380000)	48
510156S	*Wall sign, baby changing room, 304 sat. stain. s (whl stock)	-
510158	*wht polyester weighted curtain 790 × 880mm + rings (whl stk)	-
510159N	*Lift-up splash guard curtain rail L. 900 wht Nylon (whl stk)	-
510159P	*Lift-up splash guard curtain rail L. 900 pol. st s (whl stk)	-
510159S	*Lift-up splash guard curtain rail L. 900 sat. st s (whl stk)	-
510160P	Drop-down support rail Ø32 L650 polished stainless steel	95
510160S	Drop-down support rail Ø32 L650 stainless steel satin finish	95
510161P	*Wall support rail Ø32 L650 pol. ss (whl stock then 510160P)	-
510161S	*Wall support rail Ø32 L650 sat. ss (whl stock then 510160S)	-
510162P	Drop-down rail with leg Ø32 L650 polished stainless steel	95
510162S	Drop-down rail with leg Ø32 L650 stainless steel satin	95
510164P	Drop-down support rail Ø32 L850 polished stainless steel	95
510164S	Drop-down support rail Ø32 L850 stainless steel satin finish	95
510170P	Drop-down rail with leg Ø32 L850 polished stainless steel	95
510170S	Drop-down rail with leg Ø32 L850 stainless steel satin	95
510201N	Adjustable mirror 600 × 500mm with white Nylon handle	43/81
510202BK	Tilting mirror 600 × 500mm with matte black tab handle	81
510202C	Adjustable mirror 600 × 500mm with anthracite handle	43/81
510202N	Adjustable mirror 600 × 500mm with white handle	43/81
510202P	Adjustable mirror 600 × 500mm with polished handle	43
510202S	Adjustable mirror 600 × 500mm with polished satin handle	43

References prefixed by \* are available while stocks last. References are listed in ascending alphanumerical order.

REF.	DESCRIPTION	P.	REF.	DESCRIPTION	P.
510203	Mirror cabinet 600mm elec tap + elec soap disp + hand dryer	8	510622	HIGHFLOW automatic air pulse hand dryer bright st st	15
510203I	Unit with electronic tap, electronic soap disp., hand dryer	9	510622BK	HIGHFLOW automatic air pulse hand dryer matte black st st	15
510203SD	Electronic soap disp unit for installation behind the mirror	9	510622S	HIGHFLOW automatic air pulse hand dryer satin finish st. st.	15
510204	Mirror cabinet 800mm elec tap + elec soap disp + hand dryer	8	510622W	HIGHFLOW automatic air pulse hand dryer white st. st. finish	15
510205	Mirror cabinet 600mm elec tap + elec soap disp + paper towel	8	510623F	HEPA filter for SPEEDJET 2 without drip tray	173
510205I	Unit with elec tap, electronic soap disp., paper towel disp	9	510624B	SPEEDJET 2 air pulse hand dryer, matte black with reservoir	13
510206	Mirror cabinet 800mm elec tap + elec soap disp + paper towel	8	510624C	SPEEDJET 2 air pulse hand dryer, anthracite with reservoir	13
510207	Mirror cabinet 600mm electronic soap dispenser + hand dryer	8	510624F	HEPA filter for SPEEDJET 2 with reservoir	173
510207I	Unit with electronic soap disp., hand dryer	9	510624RB	Reservoir for SPEEDJET 2 black	173
510208	Mirror cabinet 800mm electronic soap dispenser + hand dryer	8	510624RC	Reservoir for SPEEDJET 2 anthracite	173
510209	Mirror cabinet 600mm elec soap disp + paper towel dispenser	8	510624RW	Reservoir for SPEEDJET 2 white	173
510210	Mirror cabinet 800mm elec soap disp + paper towel dispenser	8	510624W	SPEEDJET 2 auto air pulse hand dryer, white with reservoir	13
510300	Removable Comfort shower seat polished stainless steel	87	510625P	HIGHFLOW compact automatic air pulse hand dryer bright st st	15
510300N	Removable Comfort shower seat white pwd-ctd stainless steel	117	510625S	HIGHFLOW compact automatic air pulse hand dryer satin st st	15
510300S	Removable Comfort shower seat stainless steel satin finish	87	510627P	Wall mounted soap dish 304 stainless steel, polished	33
510400	ALU lift-up shower seat with leg	143	510627S	Wall mounted soap dish 304 stainless steel satin finish	33
510400C	*Cover for seat articulation 510400 (while stock)	-	510629	Comfort backrest for WC polished stainless steel structure	107
510400L	*3 x slats for seat 510400 (while stock)	-	510629N	Nylon Comfort backrest for WC	133
510405	BASIC + lift-up shower seat with leg	141	510629S	Comfort backrest for WC stainless steel satin finish	107
510410	ALU lift-up shower seat with leg - large model	143	510700	Wall-mounted changing table	41
510410L	*4 x slats for large seat 510410 (while stock)	-	510711S	Soap dispenser 1L rec 304 st steel satin (ex-0013200000)	22
510418	ALU shower stool	143	510712S	Paper towel dispenser rec 304 st steel satin (ex-0013120000)	22
510418L	*3 x slats for stool 510418 (while stock)	-	510713S	Bin with push flap 18L rec 304 st st satin (ex-0013320000)	22
510420	Lift-up Comfort shower seat polished stainless steel	88	510714S	Paper towel disp + 10L bin rec combi unit (ex-0013680000)	23
510420N	Lift-up Comfort shower seat white pwd-ctd stainless steel	118	510715S	Paper towel disp + 30L bin rec combi unit (ex-2015101324)	23
510420S	Lift-up Comfort shower seat stainless steel satin finish	88	510716S	Dryer, paper towel disp + bin rec combi unit (ex-0013690000)	23
510429	Comfort backrest for shower seat polished stainless steel	88/89	510788P	Single towel rail Ø20 L600 polished stainless steel	49
510429N	Comfort backrest for shower seat white pwd-ctd st steel	118	510788S	Single towel rail Ø20 L600 stainless steel satin finish	49
510429S	Comfort backrest for shower seat st steel satin finish	88/89	510788W	Single towel rail Ø20 L.600 white powder-coated st steel	49
510430	Lift-up Comfort shower seat + leg polished stainless steel	89	510790P	Double towel rail Ø20 L600 polished stainless steel	49
510430N	Lift-up Comfort shower seat with leg white powder-coated	119	510790S	Double towel rail Ø20 L600 stainless steel satin finish	49
510430S	Lift-up Comfort shower seat with leg st steel satin finish	89	510790W	Double towel rail Ø20 L.600 white powder-coated st steel	49
510434	*Cmf shwr seat + backrest pol. ss(whl stk then 510420+510429)	-	510910BK	Toilet roll holder for 400m roll, 304 matte black st steel	37
510434N	*Cmf shwr seat + br wht pwd-ctd(whl stk then 510420N+510429N)	-	510910S	Toilet roll holder for 400m roll, 304 satin stainless steel	37
510434S	*Cmf shower seat + br ss sat. (whl stk then 510420S+510429S)	-	510911BK	Toilet roll holder for 200m roll, 304 matte black st steel	37
510436	*Cmf shower seat + br + leg ss (whl stock then 510430+510429)	-	510911S	Toilet roll holder for 200m roll, 304 satin stainless steel	37
510436N	*Cmf shwr seat + br + leg wht (whl stk then 510430N+510429N)	-	511418BK	Be-Line® shower stool, black seat	67
510436S	*Cmf shwr seat + br + leg sat. (whl stk then 510430S+510429S)	-	511418C	Be-Line® shower stool, metallised anthracite seat	67
510461P	Wall mtd rect bin 25L polished 304 st steel (ex-0010350100)	19	511418W	Be-Line® shower stool, white seat	67
510461S	Wall mtd rect bin 25L 304 st steel satin (ex-0010350000)	19	511516W	Basic drop-down rail Ø32 L760 white powder-coated	146
510463P	Wall mtd rect bin 38L polished 304 st steel (ex-0010890100)	19	511517W	Drop down rail with leg Basic Ø32 L.760 white powder coated	146
510463S	Wall mtd rect bin 38L 304 st steel satin (ex-0010890000)	19	511804MC	Be-Line® DOC M WC Pack metallised anthracite	155
510465BK	Wall-mtd rectangular bin 20L matte black 304 stainless steel	19	511804MW	Be-Line® DOC M WC Pack matte white	155
510465P	Wall-mtd rectangular bin 20L polished 304 stainless steel	19	511809MC	Be-Line® DOC M WC Pack metallised anthracite with backrest	155
510465S	Wall-mounted rectangular bin 20L 304 stainless steel satin	19	511809MW	Be-Line® DOC M WC Pack matte white with backrest	155
510465W	Wall-mounted rectangular bin 20L white 304 stainless steel	19	511811MC	Be-Line® DOC M Ambulant Disabled Pack metallised anthracite	155
510567	Toilet roll holder 304 stainless steel satin finish	35	511811MW	Be-Line® DOC M Ambulant Disabled Pack matte white	155
510580	Liquid soap dispenser 1L polished 304 stainless steel	31	511903BK	Be-Line matte black aluminium grab bar Ø35mm L. 300mm	71
510581	Liquid soap dispenser 1L white powder-coated 304 st. steel	31	511903C	Be-Line grab bar Ø35 L.300 anthracite aluminium	71
510582	Liquid soap dispenser 1L 304 stainless steel satin finish	31	511903W	Be-Line grab bar Ø35 L.300 white aluminium	71
510583	Liquid soap dispenser 0.5L polished 304 stainless steel	31	511904BK	Be-Line matte black aluminium grab bar Ø35mm L. 400mm	71
510584	Liquid soap dispenser 0.5L white powder-coated 304 st.steel	31	511904C	Be-Line grab bar Ø35 L.400 anthracite aluminium	71
510585	Washer repair kit for 51058X soap dispensers	-	511904MC	Be-Line DOC M grab bar Ø35 L.450 anthracite aluminium	157
510586	Liquid soap dispenser 0.5L 304 stainless steel satin finish	31	511904MW	Be-Line DOC M grab bar Ø35 L.450 white aluminium	157
51058CO	*Lid for 51058X liquid soap dispensers (while stock)	-	511904W	Be-Line grab bar Ø35 L.400 white aluminium	71
51058M	Pump for soap dispenser 510580	172	511905BK	Be-Line matte black aluminium grab bar Ø35mm L. 500mm	71
510601BK	Folded paper towel dispenser matte black 304 stainless steel	17	511905C	Be-Line grab bar Ø35 L.500 anthracite aluminium	71
510601P	Folded paper towel dispenser polished stainless steel	17	511905W	Be-Line grab bar Ø35 L.500 white aluminium	71
510601S	Folded paper towel dispenser stainless steel satin finish	17	511906BK	Be-Line matte black aluminium grab bar Ø35mm L. 600mm	71
510601W	Folded paper towel dispenser white powder-coated	17	511906C	Be-Line grab bar Ø35 L.600 anthracite aluminium	71
510621	SPEEDJET automatic hand dryer with pulsed air grey metal	12	511906MC	Be-Line DOC M grab bar Ø35 L.600 anthracite aluminium	157
510621F	Filter for 510621 delivered after 2013	173	511906MW	Be-Line DOC M grab bar Ø35 L.600 white aluminium	157
510621FA	Filter for 510621 delivered before 2013	173	511906W	Be-Line grab bar Ø35 L.600 white aluminium	71
510621R	Reservoir for 510621	173	511909BK	Be-Line grab bar Ø35 L.900 matte black aluminium	71

References prefixed by \* are available while stocks last. References are listed in ascending alphanumerical order.

REF.	DESCRIPTION	P.	REF.	DESCRIPTION	P.
511909C	Be-Line grab bar Ø35 L.900 anthracite aluminium	71	511971W	Be-Line L-shaped grab bar Ø35 H.1130 white aluminium	75
511909W	Be-Line grab bar Ø35 L.900 white aluminium	71	511982BK	Be-Line grab bar 135° Ø35 400×400 3 fix pts black alu	69
511911BK	Be-Line shower head holder matte black	78	511982C	Be-Line grab bar 135° Ø35 400×400 3 fix pts anthracite alu	69
511911C	Be-Line sliding shower head holder anthracite	78	511982W	Be-Line grab bar 135° Ø35 400×400 3 fix pts white aluminium	69
511911W	Be-Line sliding shower head holder white	78	511983BK	Be-Line grab bar 135° Ø35 220×220 3 fix pts matte black alu	69
511912BK	Be-Line matte black sliding soap dish for Be-Line bars	78	511983C	Be-Line grab bar 135° Ø35 220×220 3 fix pts anthracite alu	69
511912C	Be-Line anthracite sliding soap dish for Be-Line bars	78	511983W	Be-Line grab bar 135° Ø35 220×220 3 fix pts white aluminium	69
511912W	Be-Line white sliding soap dish for Be-Line bars	78	5119FIX	Mounting kit for Be-Line grab bars	172
511920BK	Be-Line removable lift-up shower seat matte black alu no leg	63	5119MFX	Mounting kit for Be-Line DOC M grab bars	172
511920C	Be-Line removable lift-up shower seat anthracite alu no leg	63	511MEXP1	Be-Line® exposed shower pack metallised anthracite	153
511920W	Be-Line removable lift-up shower seat white aluminium no leg	63	511MEXP2	Be-Line® exposed shower pack matte white	153
511921FW	Be-line shelf with fixing plate for refs 511920 /511930	63/65	511MREC1	Be-Line® recessed shower pack metallised anthracite	152
511921W	Be-line shelf without fixing plate for refs 511920 /511930	63/65	511MREC2	Be-Line® recessed shower pack matte white	152
511922BK	Shelf for grab bar matte black	78	512021BK	Deck-mtd BINOPTIC liquid/foam soap disp. 1L, black, mains supply	27
511922C	Shelf for grab bar metallised anthracite	78	512021BKUK	Replaced by 512021BK	-
511922P	Shelf for chrome-plated grab bar	105	512021P	Deck-mtd BINOPTIC liquid/foam soap disp. 1L chrome, mains supply	27
511922W	Shelf for grab bar matte white	78	512021PUK	Replaced by 512021P	-
511928BK	Be-Line DOC M WC backrest matte black aluminium	79	512021S	Deck-mtd BINOPTIC liquid/foam soap disp. 1L satin, mains supply	27
511928C	Be-Line DOC M WC backrest anthracite aluminium	79	512031P	Deck-mtd T4 liquid/foam soap disp. 1L, chrome, mains supply	27
511928W	Be-Line DOC M WC backrest white aluminium	79	512031PUK	Replaced by 512031P	-
511929	Be-Line® backrest for shower seats	63/65	512036P	Deck-mtd T4 liquid soap dispenser 1L, chrome, battery-op	27
511930BK	Be-Line removable lift-up sh. seat + matte black with leg	65	512041P	Wall-mtd T4 liquid soap/foam dispenser 1L, chrome, rec mains	-
511930C	Be-Line removable lift-up sh. seat + metallic anthracite leg	65	512046P	Deck-mtd T4 liquid soap dispenser 1L, chrome battery-op	-
511930W	Be-Line removable lift-up shower seat with white leg	65	512051BK	Wall-mtd BINOPTIC liquid/foam soap disp. 1L black, mains supply	25
511941BK	Be-Line corner grab bar Ø35 695×695 matte black aluminium	76	512051BKUK	Replaced by 512051BK	-
511941C	Be-Line corner grab bar Ø35 695×695 anthracite aluminium	76	512051P	Wall-mtd BINOPTIC liquid/foam soap disp. 1L chrome, mains supply	25
511941W	Be-Line corner grab bar Ø35 695×695 white aluminium	76	512051PUK	Replaced by 512051P	-
511943BK	Be-line coat hook matte black aluminium	79	512051S	Wall-mtd BINOPTIC liquid/foam soap disp. 1L satin, mains supply	25
511943C	Be-line coat hook metallised anthracite aluminium	79	512051SUK	Replaced by 512051S	-
511943W	Be-line coat hook matte white aluminium	79	512066BK	Electronic liquid soap dispenser 1L matte black 304 st steel	29
511944BK	Be-Line T-shaped grab bar Ø35 H.1130×500 matte black alu	74	512066P	Electronic liquid soap dispenser 1L bright pol 304 st steel	29
511944C	Be-Line T-shaped grab bar Ø35 H.1130×500 anthracite alu	74	512066S	Electronic liquid soap dispenser 1L pol satin 304 st steel	29
511944W	Be-Line T-shaped grab bar Ø35 H.1130×500 white aluminium	74	512066W	Electronic liquid soap dispenser 1L white powder-ctd 304 st st	29
511946C	*Be-Line bar + slid hldr anthr (whl stk then 511909C+511911C)	-	512067BK	Matte black drip tray for dispensers 51058× and 512066×	29
511946W	*Be-Line bar + slid hldr white (whl stk then 511909W+511911W)	-	512067P	Bright polished drip tray for dispensers 51058× and 512066×	29
511949BK	Be-Line grab bar + shower head rail Ø35 matte black alu	77	512067S	Satin drip tray for dispensers 51058× and 512066×	29
511949C	Be-Line grab bar + shower head rail Ø35 anthracite aluminium	77	512067W	White drip tray for dispensers 51058× and 512066×	29
511949W	Be-Line grab bar + shower head rail Ø35 white aluminium	77	51206BC	Electronic box for 512066 + o-ring	172
511950C	Be-Line anthracite fixings cover (bars 511960-511964)	73	51206CR	*Tank cover for 512066 soap dispenser (while stock)	-
511950FC	Be-line anthracite cover plate (for bars 511960-511964)	73	5120P2	Corner grab bar 2 walls Ø32 750×750 polished stainless steel	102
511950FW	Be-line white cover plate (for bars 511960-511964)	73	5120S	Corner grab bar 2 walls Ø32 750×750 stainless steel satin	102
511950W	Be-Line white cover plate (bars 511960-511964)	73	512111BK	C-wall BINOPTIC liquid/foam soap disp L1.2m tube, black, mains	25
511960BK	Be-Line drop-down support rail Ø42mm L.650mm matte black alu	73	512111BKUK	Replaced by 512111BK	-
511960C	Be-line drop down rail Ø42 L.650 anthracite aluminium	73	512111P	C-wall BINOPTIC liquid/foam soap disp L1.2m tube, chrome, mains	25
511960W	Be-line drop down rail Ø42 L.650 white aluminium	73	512111S	C-wall BINOPTIC liquid/foam soap disp L1.2m tube, satin, mains	25
511962BK	Be-Line drop-down support rail + leg Ø42 L.650 matte blk alu	73	512121BK	Deck-mtd BINOPTIC liq/foam soap disp L1.2m tube, blk mains	27
511962C	Be-Line drop-down rail with leg Ø42 L.650 anthracite aluminium	73	512121BKUK	Replaced by 512121BK	-
511962W	Be-Line drop-down rail with leg Ø42 L.650 white aluminium	73	512121P	Deck-mtd BINOPTIC liq/foam soap disp L1.2m tube, chrome, mains	27
511963BK	Be-Line drop-down support rail + leg Ø42 L.850 matte blk alu	73	512121PUK	Replaced by 512121P	-
511963C	Be-Line drop-down rail with leg Ø42 L.850 anthracite aluminium	73	512121S	Deck-mtd BINOPTIC liq/foam soap disp L1.2m tube, satin, mains	27
511963W	Be-Line drop-down rail with leg Ø42 L.850 white aluminium	73	512121SUK	Replaced by 512121S	-
511964BK	Be-Line drop-down support rail Ø42mm L.850mm matte black alu	73	512131P	Deck-mtd T4 liquid/foam soap disp L1.2m tube, chrome, mains	27
511964C	Be-line drop down rail Ø42 L.850 anthracite aluminium	73	512131PUK	Replaced by 512131P	-
511964W	Be-line drop down rail Ø42 L.850 white aluminium	73	512136P	Deck-mtd T4 liquid soap disp, tube L.1.2m, chrome battery-op	27
511965C	Toilet roll holder for Be-Line bar anthracite	79	512141P	Wall-mtd T4 liquid soap/foam disp L.1.2m, chrome, rec mains	-
511965W	Toilet roll holder for Be-Line bar white	79	512146P	Wall-mtd T4 liquid soap disp, tube L.1.2m, chrome battery-op	-
511966BK	Wall-mtd toilet roll holder for Be-Line bar matte black	79	512151BK	Wall-mtd BINOPTIC liq/foam soap disp L1.2m tube, black, mains	25
511966C	Wall-mtd toilet roll holder for Be-Line bar metallised anthr	79	512151BKUK	Replaced by 512151BK	-
511966W	Wall-mtd toilet roll holder for Be-Line bar matte white	79	512151P	Wall-mtd BINOPTIC liq/foam soap disp L1.2m tube, chrome, mains	25
511970BK	Be-Line L-shaped grab bar Ø35 H.750 matte black aluminium	75	512151PUK	Replaced by 512151P	-
511970C	Be-Line L-shaped grab bar Ø35 H.750 anthracite aluminium	75	512151S	Wall-mtd BINOPTIC liq/foam soap disp L1.2m tube, satin, mains	25
511970W	Be-Line L-shaped grab bar Ø35 H.750 white aluminium	75	512171P	C-wall T4 liquid soap/foam disp tube L.1.2m, chrome rec mains	-
511971BK	Be-Line L-shaped grab bar Ø35 H.1130 matte black aluminium	75	5121N	Corner grab bar for shower seat Ø32 white Nylon	130
511971C	Be-Line L-shaped grab bar Ø35 H.1130 anthracite aluminium	75	512521BK	Deck-mtd BINOPTIC liquid/foam soap disp. 0.5L, black, mains	27

References prefixed by \* are available while stocks last. References are listed in ascending alphanumerical order.

REF.	DESCRIPTION	P.	REF.	DESCRIPTION	P.
512521BKUK	Replaced by 512021BK	-	612	*Hyperco robe hook x 2 hooks pol. 304 ss (whl stk then 302)	-
512521P	Deck-mtd BINOPTIC liquid/foam soap disp. 0.5L, chrome, mains	27	613	*Hyperco robe hook x 3 hooks pol. 304 ss (whl stk then 303D)	-
512521PUK	Replaced by 512021P	-	6555	Glass shelf 120x600 rounded edges	49/56
512521S	Deck-mtd BINOPTIC liquid/foam soap disp. 0.5L, satin, mains	27	6566	Hyperco liquid soap disp 1.2L 304 st steel satin finish	57
512521SUK	Replaced by 512021S	-	6567	Hyperco liquid soap dispenser 1.2L polished 304 st steel	57
512531P	Deck-mtd T4 liquid/foam soap dispenser 0.5L, chrome, mains	27	6568	Spare valve for liquid soap dispenser 6566 & 6567	57
512531PUK	Replaced by 512031P	-	6569	Spare level control for soap dispenser 6566 & 6567	57
512551BK	Replaced by 512051BK	-	6580	*Liquid soap dispenser 1L pol. ss (while stock then 510580)	-
512551BKUK	Replaced by 512051BK	-	6580SRV	Pump for soap dispenser 658x	172
512551P	Replaced by 512051P	-	6583	*Liquid soap dispenser 0.5L pol. ss (while stock then 510583)	-
512551PUK	Replaced by 512051P	-	6601	Folded paper towel dispenser polished stainless steel	18
512566BK	Electronic liquid soap dispenser 0.5L matte black 304 st steel	29	6602	Folded paper towel dispenser white powder-coated	18
512566P	Electronic liquid soap dispenser 0.5L bright pol 304 st steel	29	6603D	Hyperco folded paper towel dispenser white ABS	57
512566S	Electronic liquid soap dispenser 0.5L pol satin 304 st steel	29	6606	180 X Folded paper towels	17/18
512566W	Electronic liquid soap dispenser 0.5L white powder-ctd 304 st st	29	6607D	Folded paper towel dispenser stainless steel satin finish	18
5160N	Drop-down support rail Ø32 L650 white Nylon	123	6611	Wall mounted paper towel bin polished stainless steel	18
5161N	Wall support rail Ø32 L650 white Nylon	-	6612	Wall mounted paper towel bin white powder-coated	18
5162N	Drop-down rail with leg Ø32 L650 white Nylon	123	6613D	Automatic hand dryer with adj. nozzle 360° pol 304 st steel	16
5164N	Drop-down support rail Ø32 L850 white Nylon	123	6614	*Hand dryer with adj. nozzle 360° ss sat. (whl stk thn 6613D)	-
5170N	Drop-down rail with leg Ø32 L850 white Nylon	123	6615	*Hand dryer with adj. nozzle 360° wht ss (whl stk thn 6613D)	-
5180P2	*Grab rail 90° Ø32 300x300 pol ss (while stock then 5081P2)	-	6617	Wall mounted paper towel bin stainless steel satin finish	18
5180S	*Grab rail 90° Ø32 300x300 ss sat. (while stock then 5081S)	-	6621	Automatic hand dryer white ABS	16
530	ECO grab bar Ø25 L300 polished stainless steel	148	6624	Wall mounted hairdryer with razor plug white ABS	16
531	ECO grab bar Ø25 L400 polished stainless steel	148	6631	Automatic hand dryer polished 304 stainless steel	16
532	ECO grab bar Ø25 L500 polished stainless steel	148	6712	*Hyperco soap disp elb. ctrl 0.9L wht (whl stk thn 374001)	-
536	ECO grab bar Ø25 L600 polished stainless steel	148	710500	Wall mounted soap dish Bayblend® chrome plated matt	33
5440N	T-shaped shower handrail Ø32 1150x500 white Nylon	128	710501	Wall mounted soap dish Bayblend® chrome plated bright	33
5440P2	T-shaped shower handrail Ø32 1150x500 polished st steel	97	729008	*Soap disp strt spout 1L btl, chr brass (whl stk thn 729064)	-
5440S	T-shaped shower handrail Ø32 1150x500 stainless steel satin	97	729012	*Soap disp curved spout 1L btl, chr brass(whl stk thn 729064)	-
5441N	Sliding T-shaped grab bar Ø32 1150x500 white Nylon	128	729064	Soap disp w. cart, straight spout 1L bottle, stainless steel	32
5441P	Sliding T-shaped grab bar Ø32 1160x500 bright polished st.st.	97	729108	*Soap disp. strt spt tube L1200, chr brass(whl stk thn 729164)	-
5441S	Sliding T-shaped grab bar Ø32 1160x500 satin polished st.st.	97	729112	*Soap disp crvd spt tube L1200, chr brass(whl stk thn 729164)	-
5460N	Straight bar Ø32 +sliding block H1150 white Nylon	124	729150	*W-mtd soap disp c-wall 190, chromed (whl stock then 729170)	-
5460P2	Straight bar Ø32 +sliding block H1150 polished st steel	96	729164	Soap disp w. cartridge straight spout, tube L. 1200 st steel	32
5460S	Straight bar Ø32 +sliding block H1150 st steel satin finish	96	729170	Wall-mtd soap disp with cartridge, c-wall 190mm, st steel	32
5481DP2	Grab bar and shower rail (right) Ø32 polished st steel	101	729302	Repair kit for soap dispenser type 729150/729012	172
5481DS	Grab bar and shower rail (right) Ø32 stainless steel satin	101	729303	Cartridge for soap dispenser type 729150/729200	172
5481GP2	Grab bar and shower rail (left) Ø32 polished stainless steel	101	729305	Washer repair kit for 729 soap dispensers	-
5481GS	Grab bar and shower rail (left) Ø32 stainless steel satin	101	729308	Cartridge for soap dispenser type 729008	172
5481N	Shower grab bar and sliding white nylon vert. bar Ø32	129	729312	Cartridge for soap dispenser type 729012	172
5481P	Grab bar and sliding vert. bar Ø32 bright stainless steel	101	729500	0.5L Tank for 729 soap dispenser, union F1/2"	172
5481S	Grab bar and sliding vert. bar Ø32 satin stainless steel	101	729501	1L Tank for 729 soap dispenser, union F1/2"	172
5490N	Handrail & grab bar for shower seat Ø32 white Nylon	129	729508	*Soap disp strt spt 0.5L btl chr brass(whl stk then 729564)	-
550	ECO grab rail 135° Ø25 220x220 polished stainless steel	148	729512	*Soap disp crvd spt 0.5L btl, chr brass (whl stk then 729564)	-
551	Wall shelf 120x450 polished stainless steel	49	729564	Soap disp w. cartridge, straight spout 0.5L bottle, st steel	32
552	Wall shelf 120x450 white steel	49	729TUB	Soap dispenser mech with PVC tube + NR valve docking port	172
553	Wall shelf 120x600 polished stainless steel	49	815	Single jet shower head M1/2" Ø100mm, scale resistant	104
554	Wall shelf 120x600 white steel	49	830	Shower head retaining collar for bars Ø 25-35mm	78
566	Toilet roll holder polished 304 stainless steel	35	CPP32P	*Solid cover plate Ø72 UltraPolish polished ss (while stock)	-
566TER	Hyperco toilet roll holder polished stainless steel	56	CPP32S	*Solid cover plate Ø72 UltraSatin s steel satin (while stock)	-
569	Wall mounted rectangular soap basket polished st steel	33	SER1660V	Lock for 2-roll toilet paper dispenser	173
577	4 X Concealed lugs for mirror, 2 with spring pol st steel	44	SER2559V	Lock for hyg. accessories except JUMBO & 51058 soap dispenser	173
578	Round mirror studded peg Ø20 chrome plated brass	44	SER2911V	Lock for JUMBO & soap dispensers of 51058 type	172
600	2 X Chrome plated supports for shelf L120	49/56	SER5102V	Lock for mirror cabinet	-
610	Hyperco robe hook x 1 hook polished 304 stainless steel	56			

References prefixed by \* are available while stocks last. References are listed in ascending alphanumerical order.





**The general terms and conditions are valid for all customers.**

**ORDERS AND QUOTATIONS:**

These will be processed in order of receipt. We do not accept open orders or orders for call-off. All orders sent imply acceptance of our general terms and conditions of sale and customers waive any claims that may arise from clauses in their own documentation which may differ. The customer agrees to these terms from the moment that we receive the order, which cannot be cancelled. Orders are accepted without obligation to deliver the order in full in one delivery. Our commercial representatives are not authorised to agree additional terms verbally, or to provide verbal guarantees beyond those provided in the written contract. In the event of default or delayed payment, the Company will be entitled to suspend deliveries or cancel existing orders without any claim for damages from the customer. In the event of a change in circumstances of the buyer, we reserve the right to cancel existing orders or to demand payment guarantees. Our quotes do not amount to specifications; specifiers and professional installers are solely responsible for the choice of products according to their intended use, current regulations and recommended guidelines.

**PRICE:**

Deliveries are invoiced according to the conditions in place at the date of despatch. Prices are given without guarantee and they may be changed without notice subject to fluctuations in costs, VAT or other taxes, according to the prevailing economic conditions. Price increases will be announced one month prior to their application, and they apply to quotes and orders in hand.

**PAYMENTS:**

Terms of payments are confirmed when an account is opened, and are dependent on the terms of our credit insurance, and according to each country. We do not give discount for early payment.

In accordance with Article L441-6 of the Commercial Code, any delay in payment will give rise to the following from the first day of delay, regardless of their status with the supplier:

- An interest rate for delayed payment will be applied, equal to the European Central Bank refinancing rate plus 10% (French Law of Modernization of the Economy - LME - No. 2008-776 of 4th August 2008);
- A one-off payment of 40 Euros will apply to cover expenses (European Directive 2011/7 of 16th February 2011, Law 2012-387 of 22nd March 2012, and Decree 2012-1115 of 2nd October, 2012);
- When the recovery costs exceed the amount of the one-off payment, additional compensation will apply where justified.

In the case of late payment, a one-off payment may be required, replacing existing conditions. We will not accept any set off, only our assets have a legal value.

**DELIVERY TIMES:**

Despatch dates are indicative only and we shall not be liable for any delay or failure in carrying out our obligations where the delay or failure to deliver is caused by risks of manufacturing or where the cause is beyond our control. Delivery delay will not give rise to compensation payment or goods rejection.

**SHIPPING:**

Orders are sent to our distributors. We do not deliver to site. Charges and risks incurred from the transfer of merchandise depend on the Incoterm used for the commercial transaction. The carrier is solely responsible for their delivery, and in the event of delay, missing items, damage or other dispute, the customer must indicate this via the delivery driver's paperwork (either electronically or in hard copy) AND follow up with written notification sent by recorded delivery within 24 hours. A copy of this letter must be addressed to us.

**CLAIMS:**

No claim will be allowed where the delay in reporting exceeds 8 days following receipt of the goods. The whole of the delivery cannot be rejected because of partial damages and shortages.

**PROPERTY IN GOODS:**

Notwithstanding any agreed terms of sale, the goods shall remain the property of the seller until payment is made in full. The failure to meet a payment deadline may result in the reclamation of these goods. The buyer assumes the risks of loss or damage, regardless of the means of delivery, as described in 'DELIVERY TIMES' and 'SHIPPING' above, as well as liability for the damage they might cause.

**WARRANTY AND RESPONSIBILITY:**

Our finished goods delivered after the 1<sup>st</sup> January 2024 are warranted against any manufacturing defect for a period of 30 years, including electronic controls, excluding other electrical accessories (e.g. hand dryers, etc.) which have a 3-year warranty from the invoice date. This does not apply to products with an expiry date. Spare parts have a one-year warranty.

This warranty is limited to replacement or repair of defective components as determined by our workshops in France but excludes the costs of spoilage, handling and carriage or compensation whatever they are. We are not responsible for handling charges and the cost of returning products to our workshops.

Disasters or major water damage as a result of manufacturing defects are covered by our product and/or public liability insurance.

Our warranty and responsibility does not include the following:

- installation that does not comply with the technical specification or current recommended guidelines;
- worn parts;
- non-compliance with installation, user and maintenance guides;
- other factors independent of our products' quality, for example: detergents or abrasive cleaning products, the action of hard water, foreign bodies (e.g. gravel, sand, iron filings, scale, etc.), chemical and electrolytic phenomenon;
- lack of supervision, poor storage or poor maintenance;
- product modifications or actions by the customer, or a third party, without our authorisation using non-DELABIE components and/or consumable items.

- products past their expiry date. The water-tightness of connections, joints and the product housing is the responsibility of the professional responsible for installation, and must be guaranteed by them. Warranty excludes joints, valves, washers and rubber seals. However they would be supplied if the warranty application requires them. Any finishes other than chrome or nickel are also excluded from the warranty. In the event that the product has been discontinued or manufacturing methods have changed and replacements are not available, similar alternative products will be offered. Replacement under warranty will not extend the duration of the original warranty.

Legal warranty of latent defects applies in any event.

**SPARE PARTS:**

Spare parts and mechanisms that are essential to ensure the correct operation of our products will be held in stock for 50 years from the date of purchase. They are listed at the back of our catalogues.

**RETURNS:**

Goods may not be returned to us for credit without our prior written approval obtained by the buyer from the Company and they are received in a good state (determined by our goods inwards department). All transportation costs for returned goods must be paid by the buyer. Goods must be returned to our factory\* with good protective packaging. Deliveries less than a month old will be refunded at the invoiced price. For deliveries older than one month, a deduction will be made for checking, handling and administration costs. A repair and re-stocking fee will apply where appropriate.

Product returns are not permitted in the following circumstances: discontinued products, specially manufactured products, technical or aesthetic evolution of the product since the date of purchase, scratched or damaged products, products purchased more than one year previously, products with an expiry date. If sent to DELABIE, those products outside the scope of returns will be immediately destroyed/recycled, and will not be returned to the customer.

The schedule of standard deductions is as follows:

- return less than 1 month: refund at invoiced price
- return between 1 and 3 months: deduction of 15%
- return between 3 months and 1 year: deduction of 30%
- return after 1 year: no refund possible.
- return without prior agreement: additional deduction of 5% of the value of the goods with a minimum value of €50 excl. VAT.

\* DELABIE S.A.S.

18, rue du Maréchal Foch  
80130 Friville Escarbotin – FRANCE

**CLEANING - MAINTENANCE:**

Clean with slightly soapy water only, using a soft cloth or sponge, rinse and dry thoroughly. Do not use abrasive or chlorine-based products (with a hydrochloric acid base), or dyes.

**PHOTOGRAPHS AND DRAWINGS:**

All photos, drawings or illustrations are for illustrative purposes only, without contractual obligation, and may be subject to change without notice.

We reserve the right to modify designs and dimensions without notice and without recourse. This applies to all references, dimensions, information contained in various documents, catalogues, installation guides, price lists and websites, which can be modified or discontinued at any time without notice.

**INTELLECTUAL PROPERTY AND USE OF CONTENT:**

The content (including but not limited to the information, text, graphics, data, images, photos, visuals, videos and soundtrack, and the format of all these elements and our catalogues, websites, etc.) are protected under copyright and/or other intellectual property. The contents are the sole property of their respective editors. Any copying, reproduction, use, adaptation, alteration, modification, translation, dissemination, complete or partial, of content, whether they belong to DELABIE or a third party which has granted the rights to DELABIE, by any means whatsoever, is illegal except for the limiting rights that are granted below, and/or private copying for the exclusive use of the copier. The content presented in our communication and business tools may be subject to change without notice and are provided without warranty of any kind, express or implied, and cannot give rise to any right to compensation. Protected content may be specifically identified by the following copyright notices: © or "All rights reserved".

The names and logos appearing in our catalogues and websites are registered trademarks. These distinctive marks are the exclusive property of DELABIE or third parties who have granted the rights to DELABIE. Any use, complete or partial reproduction, or imitation of these marks is prohibited without prior express consent of DELABIE.

Alteration and modification of the contents or their use for any purpose other than that authorised, constitute an infringement of DELABIE's, or a third party's, property rights. With the following limitations, DELABIE grants you the right to download and distribute the content:

- where the download function exists
- for non-commercial purposes
- in good faith
- for maintaining the proprietary notices intact, and for the publication or posting of existing content online, if such information is stated. This right should in no way be interpreted as a trademark or copyright license for the aforementioned content.

**PERSONAL DATA PROTECTION:**

In line with the General Data Protection Regulation (GDPR), DELABIE is doing everything necessary to limit to a bare minimum the collection of personal data, and its conservation and ensure its protection.

DELABIE only uses this data for its own use for purposes of information and commercialisation of its products. It is not, under any circumstances, given to third parties.

The right of access, rectification, removal and opposition to the processing in addition to the limitation and transferability of your data is possible on request to our Data Protection Officer (DPO) at DELABIE via email (dpo@delabie.fr) or recorded delivery with a photocopy of a photo ID to the following address: DELABIE, 18 rue du Maréchal Foch, 80130 FRIVILLE, France.

To improve our services and for training purposes, calls to DELABIE may be recorded. These recordings will not be retained, and will be systematically deleted within a maximum period of 48 hours.

**EXCLUSIVE TERRITORIES:**

In most countries throughout the world, our company has entered into exclusive agreements with organisations to import and distribute our products. Within this framework, our clients cannot sell our products outside their national borders without an express prior agreement on our part.

**JURISDICTION:**

Acceptance of an order delivered from France settles the contract under the French law. All disputes arising from the present contract will be settled definitively by the Court located in the area of our domicile, even in the event of multiple defendants, regardless of the delivery location or stipulated payment. All clauses to the contrary will be considered null by the mere fact of having dealt with our company.

**AVAILABLE CATALOGUES:**

**DOC 609INT:** Water Controls for Public and Commercial Places

**DOC 900INT:** Water Controls for Healthcare Facilities and Retirement Homes

**DOC 950INT:** Accessibility and Independence - Hygienic Accessories for Public and Commercial Places

**DOC 750INT:** Stainless Steel Sanitary Ware

**DOC 200INT:** Water Controls for Professional Catering

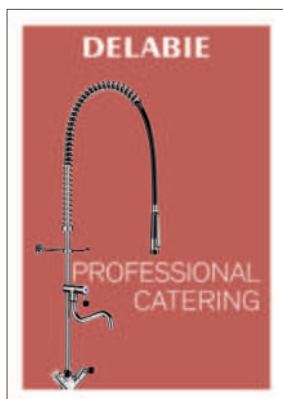
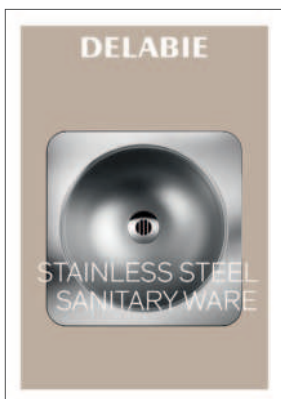
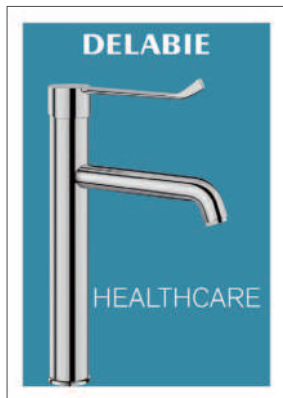
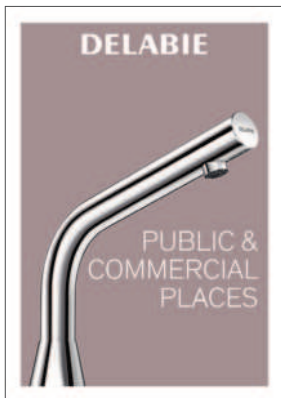

**DELABIE**

18, rue du Maréchal Foch  
80130 FRIVILLE - FRANCE

DELABIE S.A.S., share capital €999,600 - RCS 615 680 089 Amiens



[delabie.com](http://delabie.com)



DOC 950INT - 12/2023